

Rural Builder

A Construction Magazine Network Brand www.constructionmagnet.com

200+
SUPPLIERS
YOU SHOULD KNOW



2020 BUYERS' GUIDE

Suppliers
& Solutions
for Builders

SEE OUR PRODUCT
PROFILES INSIDE



October 2019 • Volume 53, Issue 7

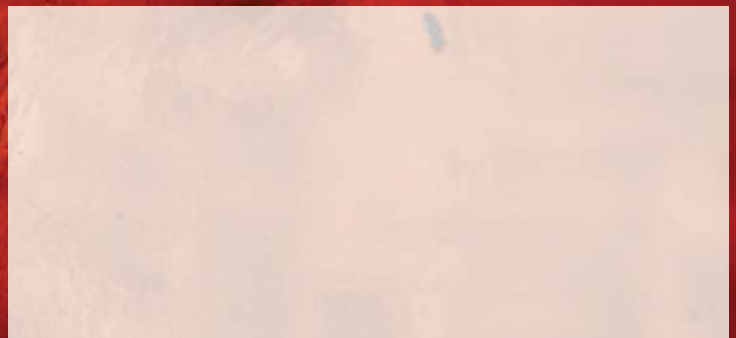

a roof is only as **GOOD**
as its **NAILS!**



- American Made Roofing Nails
- Double Hot-Dipped Galvanized & Stainless Steel
- Ring Shanks Hold Tight in High Wind Areas
- Available in Coils and Hand Drive
- Miami-Dade County Approved



1.800.435.5949 • mazenails.com
NAIL IT ONCE. NAIL IT RIGHT.®

Division of W. H. Maze Co.



Helping to build America since 1848

Celebrating 171 years • 1848-2019

Circle Reader Service #306

Rural Builder®

Editors

Karen Knapstein

karen@shieldwallmedia.com
715-598-4004

Sharon Thatcher

sharon@shieldwallmedia.com
715-257-4197

Publisher

Gary Reichert

gary@shieldwallmedia.com
715-252-6360

Designers

Tom Nelsen
Kevin Ulrich

Production Coordinator

Kathy Budsberg
kathy@shieldwallmedia.com

Circulation/Database Manager

Missy Fenn
missy@shieldwallmedia.com

Subscription Services

subs@shieldwallmedia.com

Customer Service

help@shieldwallmedia.com

Rural Builder (ISSN: 0888-3025) Volume 53 Number 7 is published monthly, except January, April, June and November, by Shield Wall Media LLC, 1990 Godfrey Dr, Waupaca, WI 54981. Periodical postage paid at Iola WI, and at additional mailing offices. Canadian Agreement Number: 40665675. POSTMASTER: Send address changes to Rural Builder, Missy Fenn, PO BOX 255, Iola WI 54945. Copyright 2019 Shield Wall Media LLC. Rural Builder and its logo are registered trademarks. Other names and logos referred to or displayed in editorial or advertising content may be trademarked or copyright. Rural Builder assumes no responsibility for unsolicited materials sent to it. Publisher and advertisers are not liable for typographical errors that may appear in prices or descriptions in advertisements. Mailed free to rural contractors and their suppliers throughout North America. Others may subscribe: \$29.98 for 1 year, \$55.98 for 2 years, and \$79.98 for 3 years in the U.S.; \$39.98 for 1 year, \$74.98 for 2 years in Canada.



NOTE FROM THE PUBLISHER

Shield Wall Media launching a new brand

According to the US Census*, 78 percent of owner-occupied houses have garages or carports. With more than 1.3 million new homes built in 2019, that adds up to over a MILLION garages or carports, not including additions and renovations.

This a huge market and source of business for our contractors that has never had its own, dedicated publication.

Until now.

In 2020, the group now operating as Shield Wall Media will introduce its second new publication in two years: *Garage, Carport & Shed Builder*. This is the only industry publication focused exclusively on this unique segment of residential construction.

Our goal is to help our readers win in a competitive market through improved creativity, marketing, and best practices to offer a top-quality product while remaining price competitive.

As a new publication we will draw on the century of combined expertise from our existing publications, but we need your support and ideas.

Feel free to contact me personally with what you think we need to cover to help you succeed.

Sincerely,

Gary Reichert

gary@shieldwallmedia.com

Publisher/CEO Shield Wall Media,
and Garage, Carport & Shed Builder Magazine

*2018 US Census Statistics



FEATURES [OCTOBER 2019]

PRODUCT GUIDE / 4

A list of products and the companies that supply them

COMPANY DIRECTORY / 12

Companies that cater to the needs of rural builders, along with their complete contact information

PRODUCT PROFILES / 34

Products to help you build the projects your customers dream of

INFOCUS / 64

Preparing for self-storage success

DEPARTMENTS

Index	58
Classified Ads.....	58
New Products.....	63
Industry News.....	69
Supplier News	70
Calendar.....	71
Money Talk.....	72

QUESTION OF THE MONTH

On what subject would you like to see more information in Rural Builder?

Drop me a line at karen@shieldwallmedia.com or mail to P.O. Box 255, Iola, WI 54945

DECEMBER PREVIEW

- Promoting Your Business Through Social Media
- Project of the Month



e-mail the editor at
karen@shieldwallmedia.com

Check our website, the Construction Magazine Network:
www.constructionmagnet.com

PRODUCT GUIDE

Your ultimate source for products and services in the rural construction industry.

HOW TO USE THE GUIDE:

The Index below is a guide to help you find companies, distributors, associations, and other organizations that provide specific products or services to the rural building industry. This Index is followed by an alphabetical listing. Many companies have included logos and/or descriptions of their businesses to explain their offerings.

Firms that won 2019 Gold Key of Excellence Awards are marked with gold keys. Companies that advertised separately in this issue can be found in our ad index on page 58. As an added convenience, the Buyers' Guide is available online at <https://www.constructionmagnet.com/buyers-guides>.



PRODUCT CATEGORIES

ADHESIVES, SEALANTS & CHEMICALS

ADHESIVES

ABC Supply Company
Albion Engineering Company
Carrington Building Products
Dynamic Fastener
EPDM Coatings
Hexion Inc.

SEALANTS & CAULKS

ABC Supply Company
Albion Engineering Company
Atlas Bolt & Screw Co.
Carrington Building Products
DB Building Fasteners
Dynamic Fastener
GSSI Sealants, Inc.
Hoover Treated Wood Products, Inc.
Marco Industries
Nationwide Protective Coating Mfrs., Inc.
Raytec Manufacturing
ST Fastening Systems
Triangle Fastener Corporation

WATERPROOFING COATINGS

Albion Engineering Company
EPDM Coatings
Hoover Treated Wood Products, Inc.
Nationwide Protective Coating Mfrs., Inc.

ANIMAL HOUSING & COMPONENTS

CURTAINS, SIDEWALLS

Palram Americas

HORSE PENS, STALLS & HARDWARE

Heritage Equine Equipment
MWI Components

LINER PANEL

AmeriLux International

Extrutech Plastics, Inc.
H&H Metal Products
Heritage Equine Equipment
Metal Rollforming Systems
Palram Americas
RAMCO Supply

LIVESTOCK FEED & WATERING SYSTEMS

Heritage Equine Equipment
Hoskins Mfg. Co., Inc.

BUILDING PACKAGES & PRODUCTS

METAL BUILDING SYSTEMS

American Building Components
Braemar Building Systems
CHIEF Buildings
Erect-A-Tube, Inc.
McElroy Metal
Sukup Manufacturing, Co.
Varco Pruden Buildings
Walters Buildings
Wrisco Industries, Inc.

MINI-STORAGE SYSTEMS

Braemar Building Systems
Lester Building Systems, LLC
McElroy Metal
Trachte Building Systems
Walters Buildings

POST-FRAME PACKAGES

Advanced Post Solutions, LLC
Energy Panel Structures
FBI Buildings, Inc.
Graber Post Buildings
Lester Building Systems, LLC
McElroy Metal
Morton Buildings
RAMCO Supply
Rigidply Rafters, Inc.
Walters Buildings
Wick Buildings

BUILDING PANELS

FIBERGLASS/PLASTIC/POLYCARBONATE

AmeriLux International
CannonBall:HNP
Direct Metals, Inc.
Kennedy Insulation Group
Palram Americas

METAL PANELS, ARCHITECTURAL

Braemar Building Systems
Fabral
Garland Company, The
Graber Post Buildings
MBCI
McElroy Metal
Metal Panels, Inc.
Metal Rollforming Systems
Paint Valley Parts / Acu-Form
Petersen Aluminum Corp.
Prassas Metal Products, Inc.
Wrisco Industries, Inc.

METAL PANELS, FOAM CORE

CHIEF Buildings
Varco Pruden Buildings
Wrisco Industries, Inc.

METAL WALL PANELS, UNINSULATED

American Building Components
Braemar Building Systems
CHIEF Buildings
Fabral
Garland Company, The
McElroy Metal
Metal Panels, Inc.
RAMCO Supply
Sukup Manufacturing, Co.
Varco Pruden Buildings
Wrisco Industries, Inc.

STRUCTURAL INSULATED PANELS

Energy Panel Structures

SINCE 1951

FASTENERS & CLOSURES
RIDGE VENTS
STALLS
CHAMPION TRACK & HARDWARE COMPONENTS
CLOSURES
DOORS
WALK DOORS
POST FRAME
CUPOLAS
DUTCH DOORS
INSULATION
WALL VENTS
COMMERCIAL
BUILD PLYCO STRONG

ONE WORD IN CONSTRUCTION EXCELLENCE

Since 1951, one word in the post frame and commercial construction industry has become synonymous with quality products and excellence in customer service – **PLYCO**. Plyco continues to stand by you and their commitment to providing a full line of products that surpass building codes and customer expectations. **Build PLYCO Strong**



PLYCO
CORPORATION
Elkhart Lake, Wis.

www.plyco.com • 800.558.5895

WINDOWS • WALK DOORS • WALL VENTS • RIDGE VENTS
SLIDING DOOR TRACK • SLIDE DOOR RAILS • PLY-FOIL INSULATION
HORSE STALLS • FASTENERS & CLOSURES • SPECIALTY PRODUCTS

Circle Reader Service #313

BUSINESS RESOURCES & SOFTWARE

ASSOCIATIONS AND/OR TRADE SHOWS/ CONFERENCES

International Roofing Expo
Metal Construction Association

CONSTRUCTION MANAGEMENT BOOKS/REFERENCES

AMS Controls
Frame Building News
Idea Book, The
Metal Roofing Magazine
Rollforming Magazine
Rural Builder
Source Book, The

SHOP DRAWINGS

Innerwall Shop Drawings

SOFTWARE, COST ANALYSIS/ESTIMATING

Applicad USA, Inc.
Construction Maestro/Symun Systems
Viking Equipment Finance

SOFTWARE, ACCOUNTING

Viking Equipment Finance

CONCRETE

PRODUCTS & EQUIPMENT

Albion Engineering Company
Brut Post Grabber, The
Extrutech Plastics, Inc.
Fascut Industries, Inc.
Hershey's Metal Meister
Midwest Perma-Column
Reflectix, Inc.

INSULATED CONCRETE FORMS (ICFS)

Benchmark Foam, Inc.

DOORS & WINDOWS

DOOR HARDWARE & TRACK

A.J. Manufacturing, Inc.
CannonBall:HNP
Delden Garage Doors
Heritage Equine Equipment
Hörmann, LLC
MWI Components
Plyco Corporation
Safe-Way Garage Doors, LLC

DOOR SYSTEMS

Delden Garage Doors
Midland Door Solutions
Plyco Corporation
PowerLift Hydraulic Doors
Safe-Way Garage Doors, LLC

Schweiss Doors

DOORS, AUTOMATIC OPENERS

Delden Garage Doors
Hi-Fold Door Corporation
Hörmann, LLC
Midland Door Solutions
Safe-Way Garage Doors, LLC
Schweiss Doors

DOORS, BIFOLD

Erect-A-Tube, Inc.
Hi-Fold Door Corporation
Midland Door Solutions
PowerLift Hydraulic Doors
Schweiss Doors

DOORS, OVERHEAD

Delden Garage Doors
Hi-Fold Door Corporation
Hörmann, LLC
Midland Door Solutions
PowerLift Hydraulic Doors
Safe-Way Garage Doors, LLC
Schweiss Doors

DOORS, ROLLUP

American Building Components
CannonBall:HNP
Delden Garage Doors
PowerLift Hydraulic Doors
Safe-Way Garage Doors, LLC
Trac-Rite Door

DOORS, SLIDING

Erect-A-Tube, Inc.
Heritage Equine Equipment
Hörmann, LLC
Midland Door Solutions
MWI Components
Plyco Corporation
PowerLift Hydraulic Doors
Rigidply Rafters, Inc.
Silvercraft

DOORS, SWINGING

Extrutech Plastics, Inc.
Heritage Equine Equipment
Schweiss Doors
Silvercraft

DOORS, WALK-THROUGH

A.J. Manufacturing, Inc.
CannonBall:HNP
Plyco Corporation
Silvercraft

LOCKS & LOCKSETS

A.J. Manufacturing, Inc.
Hörmann, LLC
Plyco Corporation

WINDOWS

A.J. Manufacturing, Inc.
Plyco Corporation

EXTERIOR & INTERIOR FINISHES

AWNINGS & CANOPIES

AmeriLux International

BRICK, STONE & MASONRY FACADES

Arkema Inc.
Replications Unlimited, LLC

CURTAINWALL

Arkema Inc.
Wrisco Industries, Inc.

EXTERIOR MOLDING & TRIM, DECORATIVE

Replications Unlimited, LLC

METAL TRIM & FASCIA

Arkema Inc.
EDCO Products, Inc.
Graber Post Buildings
H&H Metal Products
Klauer Manufacturing, Co.
Metal Panels, Inc.
Metal Rollforming Systems
RAMCO Supply
Roll Former Corporation
Van Mark Products

SIDING (METAL, STEEL OR VINYL)

American Building Components
Arkema Inc.
EDCO Products, Inc.
MBCI
Metal Rollforming Systems

SOFFIT (METAL, STEEL, PLASTIC OR VINYL)

EDCO Products, Inc.
GutterSupply.com
Metal Rollforming Systems

ARCHITECTURAL ACCENTS

Arkema Inc.
Benchmark Foam, Inc.

FASTENERS & CONNECTORS

ANCHOR BOLTS

DB Building Fasteners
Dynamic Fastener
East Coast Fasteners
Leland Industries
Midwest Perma-Column
ST Fastening Systems

ENGINEERED WOOD CONNECTORS

Perma-Column LLC
SFS

METAL PANEL FASTENERS

A.B. Martin Roofing Supply, LLC
AceClamp by PMC Industries, Inc.
Atlas Bolt & Screw Co.

FOREVER



YOUNG

Ceranamel XT-40S™

Because Ceranamel XT-40S™ ceramic/porcelain-type finish is harder and more resistant to abrasions and stains than conventional coatings, as years pass, your residential or commercial roofs and sidings will hardly show their age. And hard is the reason – the Ceranamel two-part primer/finish system forms a rock-hard surface that protects against transit and installation abrasion, resists UV and color and gloss fading, and features cool roof pigments for Energy Star, LEED and Cool Roof compliance.

Durapon 70®

PVDF resin is blended with Dura Coat's proprietary acrylic resins to produce one of the strongest, longest-lasting coatings to resist the ravages of time and elements. Durapon 70 stands up beautifully to environments and industrial pollutants, scratching, scuffing, marring, staining, transit abrasion and UV rays. With minimal chalking or fading, Durapon 70 is our green answer to the fountain of youth.

Dura Coat
P R O D U C T S
An Axalta Coating Systems Company
A P P L I E D S C I E N C E



CALIFORNIA • (951) 341-6500 • ALABAMA • (256) 350-4300 • www.duracoatproducts.com



National Coil Coating Association



Metals Service Center Institute



Circle Reader Service #581

BECK America
Day Glow Industrial Co., LTD
DB Building Fasteners
Direct Metals, Inc.
Dynamic Fastener
East Coast Fasteners
Leland Industries
S-5!
SFS
ST Fastening Systems
Triangle Fastener Corporation

NAILS

Maze Nails

NUTS & BOLTS

DB Building Fasteners
Dynamic Fastener
Leland Industries

RIVETS

Atlas Bolt & Screw Co.
DB Building Fasteners
Dynamic Fastener
East Coast Fasteners
Raytec Manufacturing
SFS
ST Fastening Systems
Triangle Fastener Corporation

SCREWS

AmeriLux International
Atlas Bolt & Screw Co.
Day Glow Industrial Co., LTD
DB Building Fasteners
Direct Metals, Inc.
Dynamic Fastener
East Coast Fasteners
Kennedy Insulation Group
Leland Industries
Levi's Building Components
Plyco Corporation
Raytec Manufacturing
ST Fastening Systems

STAPLES

Dynamic Fastener

HEATING, COOLING & VENTILATING

CUPOLAS & WEATHERVANES

A.B. Martin Roofing Supply, LLC
CannonBall:HNP
GutterSupply.com
MWI Components
Plyco Corporation

FOAM/VENTED CLOSURE STRIPS

AmeriLux International
Carrington Building Products
Direct Metals, Inc.
Leland Industries
Levi's Building Components
Marco Industries
ST Fastening Systems
Ventco

RADIANT SYSTEMS & COMPONENTS

Indiana Warm Floors, Inc.

RIDGE/SOFFIT VENTS

Aztec Washer Co., Inc.
Klauer Manufacturing, Co.
Marco Industries
MWI Components
Plyco Corporation
Snap-Z
Ventco

SOLAR ENERGY COMPONENTS

AceClamp by PMC Industries, Inc.

INSULATIONS & MOISTURE/ VAPOR BARRIERS

HOUSEWRAP

Covertch / rFOIL
NOFP, Inc.
Tape Products Company

INSULATION, FOAM BOARD

Benchmark Foam, Inc.
Hershey's Metal Meister
Indiana Warm Floors, Inc.
NOFP, Inc.

INSULATION, OTHER

Benchmark Foam, Inc.
Covertch / rFOIL
Filc USA - makers of DRIPSTOP
Hershey's Metal Meister
NOFP, Inc.
Reflectix, Inc.

INSULATION, REFLECTIVE

Benchmark Foam, Inc.
Covertch / rFOIL
Kennedy Insulation Group
Nationwide Protective Coating Mfrs., Inc.
NOFP, Inc.
Plyco Corporation
Reflectix, Inc.
Tape Products Company

MOISTURE BARRIERS

Covertch / rFOIL
Filc USA - makers of DRIPSTOP
Hershey's Metal Meister
MFM Building Products
Nationwide Protective Coating Mfrs., Inc.
Tape Products Company

PLASTIC FILM

Tape Products Company

VAPOR BARRIERS

Covertch / rFOIL
Filc USA - makers of DRIPSTOP
H&H Metal Products
MFM Building Products
NOFP, Inc.
Reflectix, Inc.

LUMBER & SHEATHING

ENGINEERED LUMBER

Starwood Rafters, Inc.

GLULAMS

Rigidply Rafters, Inc.
Starwood Rafters, Inc.

TREATED LUMBER

Hoover Treated Wood Products, Inc.
Midwest Perma-Column

METAL CONSTRUCTION COATINGS & COMPONENTS

CLOSURES, METAL PANELS

Plyco Corporation
RAMCO Supply

PAINT/COATINGS

AkzoNobel
Arkema Inc.
Dura Coat Products
Kynar Aquatec
Sherwin-Williams Coil Coatings
Steel Dynamics, Inc.

METAL COIL SUPPLIERS

Prassas Metal Products, Inc.
Steel Dynamics, Inc.

ROOFING & RELATED PRODUCTS

GUTTER PROTECTION SYSTEMS

Englert, Inc.
GutterBrush Gutter Guard
GutterSupply.com
Midwest Enterprises
Raytec Manufacturing
Van Mark Products

GUTTERING, WATER CARRYING PRODUCTS

ABC Supply Company
Advanced Architectural Sheet Metal & Supply
Englert, Inc.
GutterSupply.com
Klauer Manufacturing, Co.
Raytec Manufacturing

MEMBRANE ROOFING

Garland Company, The
MFM Building Products

METAL ROOFING, SHINGLES/TILES

ABC Supply Company
AceClamp by PMC Industries, Inc.
EDCO Products, Inc.
Garland Company, The
Klauer Manufacturing, Co.

DESIGNED FOR YOU. DESIGNED TO LAST.



Sukup

STEEL BUILDINGS



Whether you need an agricultural building to house livestock, materials, or large machinery, or you are looking for an industrial or commercial structure, you can have it with a Sukup Steel Building.

Why Purchase A **SUKUP STEEL BUILDING?**

- Clear Span up to 200'
- Purlins, Girts, and Eave Struts are pre-punched to ensure proper fit & faster installation.
- Factory Welded Clips mean fewer pieces & bolts, lowering construction costs.
- Purlins, Girts, and Eave Struts are galvanized for long life.



Find your local Sukup Dealer:
www.sukup.com/Dealer-Locator



DO YOU HAVE A PROJECT TO SHOW OFF IN THE 2020 RURAL BUILDER SOURCE BOOK?

In addition to advertising opportunities, the **Source Book** offers a great opportunity to show everyone what you can do as a builder or supplier. If you have a nice project you'd like considered for inclusion, we're looking for finished post frame and metal building projects, with information about the building and the products used in its construction. If your project or product makes it into the magazine, you'll have bragging rights for all your promotional materials!

FOR ADVERTISING OPPORTUNITIES

Contact gary.reichert@shieldwallmedia.com
715-252-6360

FOR EDITORIAL OPPORTUNITIES

Contact karen@shieldwallmedia.com
715-598-4004

Mark Your Calendar!
Space Reservation
Deadline: July 30, 2020

Rural Builder

The *Rural Builder Source Book* is published by the team at *Rural Builder* and mailed to its 29,000+ subscribers.

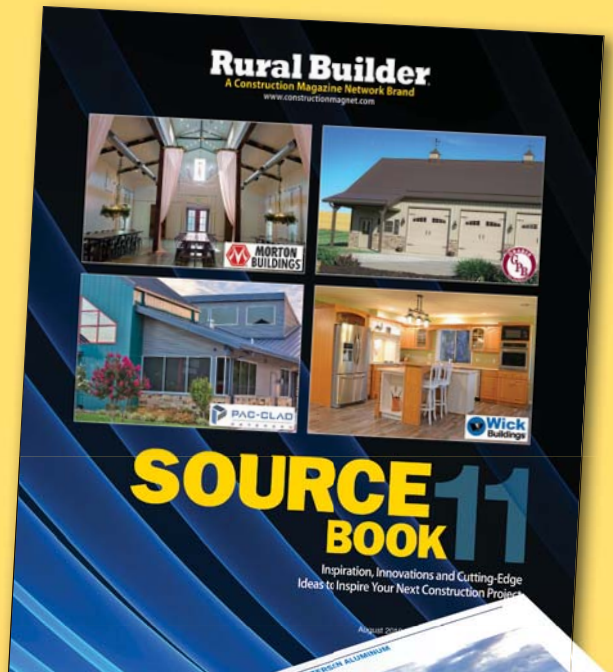

A.B. Martin Roofing Supply, LLC
 AceClamp by PMC Industries, Inc.
 Braemar Building Systems
 Central States Mfg.
 CHIEF Buildings
 Englert, Inc.
 Everlast Roofing, Inc.
 Fabral
 Graber Post Buildings
 H&H Metal Products
 MBCI
 Metal Panels, Inc.
 Metal Rollforming Systems
 NOFP, Inc.
 Petersen Aluminum Corp.
 Prassas Metal Products, Inc.
 Rigidply Rafters, Inc.
 Roll Former Corporation
 Varco Pruden Buildings
 WindBar

METAL ROOFING, THRU-FASTENED

A.B. Martin Roofing Supply, LLC
 American Building Components
 Central States Mfg.
 CHIEF Buildings
 Englert, Inc.
 Everlast Roofing, Inc.
 Fabral
 H&H Metal Products
 Lester Building Systems, LLC
 MBCI
 Metal Panels, Inc.
 Metal Rollforming Systems
 Prassas Metal Products, Inc.
 Varco Pruden Buildings

PLASTIC/VINYL FIBERGLASS ROOFING

Palram Americas

ROOF RECOATINGS

Arkema Inc.
 Dynamic Fastener
 EPDM Coatings
 Garland Company, The
 Kynar Aquatec

ROOFING UNDERLAYMENT

Filc USA - makers of DRIPSTOP
 H&H Metal Products
 Levi's Building Components
 Marco Industries
 MFM Building Products

SKYLIGHTS

Direct Metals, Inc.
 Palram Americas

SNOW GUARDS/SNOW MANAGEMENT

A.B. Martin Roofing Supply, LLC
 AceClamp by PMC Industries, Inc.
 Dynamic Fastener
 EDCO Products, Inc.
 Fabral
 GutterSupply.com
 Indiana Warm Floors, Inc.
 Levi's Building Components



S-5!
 ST Fastening Systems

TOOLS & EQUIPMENT

HAND TOOLS/POWER TOOLS

ABC Supply Company
 Albion Engineering Company
 BECK America
 Dynamic Fastener
 RUSTGO Mobile Work Platforms
 Spin Screed
 Triangle Fastener Corporation
 Van Mark Products

METAL ROLL FORMERS, PORTABLE

ASC Machine Tools, Inc.
 Bradbury Co., Inc., The
 Englert, Inc.
 Hayes International
 New Tech Machinery Corp.
 Paint Valley Parts / Acu-Form
 Roll Former Corporation

METAL ROLL FORMERS, STATIONARY

ASC Machine Tools, Inc.
 Bradbury Co., Inc., The
 Bradbury Group Australia
 Hayes International
 Hershey's Metal Meister
 Marion Manufacturing, Inc.
 Metal Rollforming Systems
 Paint Valley Parts / Acu-Form
 Roll Former Corporation

METAL FABRICATION TOOLS, BRAKES

ASC Machine Tools, Inc.
 Bradbury Group Australia
 Dynamic Fastener

Fascut Industries, Inc.
 Hershey's Metal Meister
 Paint Valley Parts / Acu-Form
 Swenson Shear
 Van Mark Products

SAFETY EQUIPMENT

Dynamic Fastener
 RUSTGO Mobile Work Platforms

WORK PLATFORMS

Dynamic Fastener
 RUSTGO Mobile Work Platforms

TRUSSES, COLUMNS & ASSEMBLY EQUIPMENT

COLUMNS, POST-FRAME

Advanced Post Solutions, LLC
 Brut Post Grabber, The
 Graber Post Buildings
 Midwest Perma-Column
 Perma-Column LLC
 Starwood Rafters, Inc.

POST SLEEVES

Post Protector

TRUSSES

Graber Post Buildings
 Starwood Rafters, Inc.

POST INSTALLATION EQUIPMENT/TOOLS

Brut Post Grabber, The

COMPANY DIRECTORY



A.B. Martin Roofing Supply, LLC

82 Garden Spot Rd.
Ephrata, PA 17522
717-500-2753
717-977-5175 (fax)
sales@abmartin.net
www.abmartin.net



We get it. With as busy as you are, it's hard to stay on top of lead times and order deadlines to keep projects on schedule. We make your life easier with over 35,000 building products that we stock and manufacture for when you need it ...YESTERDAY!



A.J. Manufacturing, Inc.

1217 Oak St.
Bloomer, WI 54724
715-568-9448
800-328-9448
715-568-3099 (fax)
info@ajdoor.com
www.ajdoor.com



AJ: your source for steel entry doors, aluminum and vinyl windows and the exclusive EZ-V™ vinyl window trim system. AJ has the right product for every building. Shutters, doors, windows, and trim are available in custom colors. AJ products are built using the highest quality raw materials and attention to detail for a quality product every time.



ABC Supply Company

1 ABC Parkway
Beloit, WI 53511
608-362-7777
608-362-2062 (fax)
www.abcsupply.com
ABC Supply is the nation's largest whole-



sale distributor of roofing and one of the largest distributors of siding, windows and other select exterior and interior building products. With locations nationwide, the company has distinguished itself by taking care of professional contractors better than any other distributor.



AceClamp by PMC Industries, Inc.

87 Spring Lane
Plainville, CT 06062
860-351-0686
860-351-0689 (fax)
bmercier@pmcind.com
www.aceclamp.com

AceClamp® is a manufacturer of precision-engineered snow retention & solar mounting systems. AceClamp is setting the bar in solar racking with its newest innovative product, "Solar Snap." "Solar Snap," an Adaptive Solar Racking System, works on every roof using our ever-popular, fully-assembled, non-penetrating clamps. Simplify inventory with one clamping system.

Advanced Architectural Sheet Metal & Supply

131 West 2nd St.
Shelby, MI 49455
231-861-0050
231-861-0075 (fax)
info@advarchsm.com
www.advarchsm.com



Green Post™

Advanced Post Solutions, LLC

PO Box 108
1564 Main St.
East Earl, PA 17519
610-377-3270
610-377-9552 (fax)
info@advanced-sol.com
http://www.advanced-sol.com/
GreenPost protects in-ground wood ap-

plications from the elements. Field tested, the lighter and easier-to-install GreenPost is heat sealed to the lumber and delivered ready to install. Non-toxic, environmentally friendly and termite tested, the GreenPost is a barrier around the treated wood, protecting the critical ground line area where decay occurs. The pre-applied proprietary uplift restraint system deters post withdrawal from stresses generated by wind load. GreenPost complies with today's safer building code practices, for post-frame construction, outdoor pavilions, or tension posts. ICC Approved.

AkzoNobel

AkzoNobel

1313 Windsor Ave.
Columbus, OH 43211
800-294-3361
coil.coatings@akzonobel.com
www.akzonobel.com/ccna



AkzoNobel manufactures high-performance coatings to meet the needs of the metal construction industry. Our products include TRINAR, a 70 percent PVDF coating, and CERAM-A-STAR 1050, the benchmark of SMP paint systems. Both products are available in our Cool Chemistry formulations, which help make projects more energy efficient and sustainable. AkzoNobel coatings are widely specified for their excellent performance and durability, as well as their color and gloss retention.



Albion Engineering Company

1250 N. Church St.
Moorestown, NJ 08057
856-235-6688
sales@albioneng.com
www.albioneng.com
Professional-quality dispensing tools powered by hand, air, or cordless battery for single and multi-component sealants, adhesives, acrylics, and epoxies. Complete engineering service for custom dispensing applications.



American Building Components

1099 US-421
Frankfort, KY 40601
800-877-8709
contact@abcmetal.com
www.abcmetalroofing.com
American since 1908 - Tirelessly committed to quality products and exceptional service, American Building Components (ABC) has built a strong reputation of providing premium metal roofing and building solutions that customers have relied on for more than a century. Servicing primarily the agricultural, residential, commercial and post-frame markets, ABC offers an expansive line of premium metal roofing and siding panels in both 29- and 26-gauge steel, as well as accompanying trim and accessories. In addition, we offer roll-up doors, steel buildings and insulated metal panels all under one roof for your convenience. Utilizing our nationwide network of manufacturing facilities and distributors, as well as our top grade painting technologies in our coating facilities, our painted steel is backed by industry-leading warranties that assure your projects will stand the tests of time. ABC metal roof and wall panels, trim and accessories are available to order online at shop.abcmetalroofing.com.

AmeriLux International

1212 Enterprise Dr.
DePere, WI 54913
920-336-9300
920-336-9301 (fax)
www.ameriluxinternational.com

AMS Controls

12180 Prichard Farm Rd.
Maryland Heights, MO 63043
314-344-3144
314-344-9996 (fax)
www.amscontrols.com

Applicad USA, Inc.

1340 US Hwy. 1
Jupiter, FL 33469
800-966-1698
800-966-1698
561-748-0546 (fax)
ray@applicad.com-au
www.applicad-usa.com



Arkema Inc.

900 First Ave.
King of Prussia, PA 19406
610-205-7874
610-205-7497 (fax)

ron.partridge@arkema.com
www.kynar500.com
Arkema proudly offers Kynar 500 FSF technology for use in superior performance metal roof coatings. Celebrating over 50 years of proven protection, Kynar resin-based coatings provide protection against weathering, aging, and pollution

on commercial, industrial, and residential buildings worldwide. Arkema produces Kynar 500 FSF PVDF resin using a patented fluorosurfactant-free (FSF) process. No fluorosurfactant of any kind is used to manufacture Kynar 500 resin, making it a key component of sustainable design.

RIGIDPLY RAFTERS INC.

**PAVILIONS › ARCHES
HEAVY TIMBER TRUSSES
BRIDGES › POSTS › BEAMS**

701 E. Linden Street, Richland PA 17087
WWW.RIGIDPLY.COM
717.866.6581

Circle Reader Service #382



ASC Machine Tools, Inc.

900 N. Fancher Rd.
Spokane, WA 99212
509-534-6600
509-536-7658 (fax)
salesupport@ascmt.com
www.ascmt.com



With more than 70 years of experience we have developed a reputation for innovation, quality and responsiveness in the design of our rollforming machinery. ASC manufactures the industry's most innovative rollforming equipment to produce roof and wall panels, trim profiles, C/Z purlins, grain bin components, decking and much more! Let us "Shape Your Success"!

Atlas Bolt & Screw Co.

1628 Troy Rd.
Ashland, OH 44805
800-321-6977
419-289-2564 (fax)
www.atlasfasteners.com



Aztec Washer Co., Inc.

13821 Danielson St.
Poway, CA 92064
858-513-4350
858-513-4305 (fax)
matt@aztecwasher.com
www.aztecwasher.com
Leading manufacturer of roof vent flashings and pipe flashings.



BECK America

105 Industrial Dr.
Muscle Shoals, AL 35661
800-239-8665
sales@fascoamerica.com
www.fascoamerica.com
BECK America® is the Master Distributor for products manufactured by The BECK Fastener Group®, a leader for generations in pneumatic tool and fastener development and creator of the RoofLoc® SCRAIL® Metal Roofing System.

Benchmark Foam, Inc.

401 Pheasant Ridge Dr.
Watertown, SD 57201
605-886-8084
605-886-8099 (fax)
epsinfo@benchmarkfoam.com
www.benchmarkfoam.com

Blocksom & Co.

110 Menke Rd.
Michigan City, IN 46360
219-878-4455
219-874-3752 (fax)
gpickford@blocksom.com
www.blocksom.com



Bradbury Co., Inc., The

1200 E. Cole
Moundridge, KS 67107
620-345-6394
620-345-6381 (fax)
bradbury@bradburygroup.com
www.bradburygroup.com
The Bradbury Co., Inc. manufactures a wide range of equipment for the metal building, roofing and post-frame industries including in-plant and portable roll formers, integrated felt wicking applicators, trim folders, CTL/slitter lines, fully automated trim lines and related coil-processing equipment. All Bradbury machines are engineered for easy operation and durability.



Bradbury Group Australia

82-88 Meakin Rd.
Meadowbrook, QLD 4131
+61.7.3299.3111
+61.7.3299.5511 (fax)
Sales@bradburygroupaustralia.com.au
www.bradburygroupaustralia.com
Bradbury Group Australia is a leading manufacturer of sandwich panel laminating equipment, and rainwater goods since 1976.

Braemar Building Systems

925 W. Kenyon Ave. #6
Englewood, CO 80110
888-480-5552
303-788-9996 (fax)
sales@braemarbuilding.com
www.braemarbuildings.com



Brut Post Grabber, The

PO Box 124
Blanchard, ID 83804-0124
208-217-0597
208-437-0196 (fax)
scott@thebrutpostgrabber.com
www.TheBrutPostGrabber.com
Anyone setting heavy post and poles will incomparably benefit from using these revolutionary skid steer attachments. This is the safest, quickest, easiest and most cost-effective answer on the market to post setting issues. Post, pole and Perma Column setting will be virtually effortless. View videos on our website.



CannonBall:HNP

555 Lawton Ave.
Beloit, WI 53512
800-766-2825
800-834-7447 (fax)
katel@cnbhnp.com
www.cnbhnp.com
CannonBall offers a wide variety of components for the post frame, commercial and metal building industries, including sliding door track systems, entry doors, Dutch/country slider doors, windows, polycarbonate/PVC sheeting, ridge vents, building materials, ventilation products, horse stall accessories, and construction hardware.



Carrington

Carrington Building Products

1224 Longleaf Dr.
Gallatin, TN 37066
615-206-0900
615-206-1800 (fax)
carringtonsp@gmail.com
www.carrington-specialty.com
Carrington Building Products manufactures and distributes accessory components for

the metal roofing/building industries. We are committed to having products in all sizes, shapes and colors stocked on our floor for almost immediate shipment to your warehouse or job site. We stock our patented Dri-Vent2 vented closure strip, Dri-Vent2 roll, flashers (pipe boots) in all types, colors and sizes, sealant/caulk in a variety of colors, underlayment, butyl tapes in multiple widths, expanding foam tapes, hundreds of standard closure strip profiles, as well as custom void fillers for specific job requirements.



Central States Mfg.

302 Jane Pl.
Lowell, AR 72745
800-356-2733
800-356-2971 (fax)
info@centralstatesmfg.com
www.centralstatesmfg.com
CSMI offers eight different high-quality panel profiles to customers throughout the United States in post-frame, commercial

and residential markets. Experience the Central States difference for yourself. Right. On Time. Every Time.



CHIEF Buildings

1821 S. North Rd.
Grand Island, NE 68803
800-845-1767
buildings@chiefind.com
www.chiefbuildings.com
CHIEF Buildings is one of the largest family owned metal building manufacturers in the United States. We pride ourselves on producing quality products and providing unparalleled personal attention to meeting the needs of our customers. For farm or commercial use, CHIEF Buildings can deliver. Trusted. Tested. True. Since 1954.



Construction Maestro/Symun Systems

3469 Pierson Pl., Suite B

Flushing, MI 48433
810-230-8920
888-220-6230
810-230-8926 (fax)
mike@symun.com
www.symun.com



Covertch / rFOIL

279 Humberline Dr.
Etobicoke, Ontario M9W 5T6
416-798-1340
416-798-1342 (fax)
johnstarr@covertchfab.com
www.rfoil.com

rFOIL™ Reflective Insulation is a patented technology manufactured by Covertch Fabricating Inc. It is specially designed to control heat gain or loss while preventing interior condensation in all types of post frame, metal and metal-clad buildings. rFOIL™ is a CLASS 1/A fire rated product which blocks up to 96 percent of radiant heat transfer. It is easy to handle and install, will not promote mold or mildew and passes the NFPA 286 full-room burn test.



IN A WORLD WITH HAZARDS YOUR PAINT SYSTEM SHOULDN'T BE ONE OF THEM

When dealing with harsh environments the last thing you want to leave for chance is your paint system. At Everlast, your color will last longer. Our paint system provides superior protection and resistance against weather and UV exposure. Backed by 50 years of extensive research with both field and real-world testing, our panels have surpassed all other pre-painted steel.

Available in 18 long-lasting colors through Everlast Roofing, Inc.

Mid-Atlantic

10 Enterprise Court
Lebanon, PA 17042

Midwest

7180 N 050 E
Howe, IN 46746

Central

161 Grand Valley Ave
Orwell, OH 44076

New England

24 JR Mains Drive
Bridgton, ME 04009



EVERLASTROOFING.COM
888.339.0059

Circle Reader Service #407



Day Glow Industrial Co., LTD

No. 921-11, Chungshan Rd., Sec. 2, Tachia Dist.

Taichung City, Taiwan 43767

886-4-268-14343

886-4-268-14304 (fax)

www.dayglow.com.tw

DAY GLOW INC. has been a specialist maker of drilling and tapping screws since 1996. Located in Tai'Chung, Taiwan, Day Glow has several years experience in metal building construction, and hence realizes the importance of screws. We focus on producing high-quality screws, from standard screws to customized screws.



DB Building Fasteners

5555 E. Gibraltar St.

Ontario, CA 91764

909-581-6740

909-581-6745 (fax)

brentd@selfdrillers.com

www.selfdrillers.com

DB is proud to offer same-day shipments on all stocked items. In-house paint and closure production is done in our Los Angeles warehouse. DB is now in Sacramento, CA and Laredo, TX. Call DB today for all your import and domestic fastener needs.



"Experience the Quality"

Delden Garage Doors

3530 N. Kimball Dr.

Kansas City, MO 64161

816-413-1600

816-413-1699 (fax)

sales@deldenmfg.com

www.deldenmfg.com



Direct Metals, Inc.

1800 Jim Neu Dr.

Suite 3



Plymouth, IN 46563

855-800-8878

239-599-8545 (fax)

orders@directmetalsinc.com

www.directmetalsofindiana.com

DMI is a manufacturer and master distributor of many products for the post-frame building market including fasteners, flashings, translucent panels, closures, sealants and panel clips. Our Midwest service center in Plymouth, Indiana, can offer same day shipping on millions of in-stock products.



Dura Coat Products

26655 Peoples Rd.

Madison, AL 35756

256-350-4300

256-353-9873 (fax)

info@duracoatproducts.com

www.duracoatproducts.com

Dura Coat Products offers two high-performance coil coatings: Durapon 70™ is a PVDF formulation with exceptional durability and fade resistance that is also available with thick film primer for the tougher environments. Ceranamel™ XT-40 SMP is a proprietary polymer that is harder yet more flexible than ordinary coatings. Both are Energy Star compliant.



Dynamic Fastener

9911 E. 53rd St.

Raytown, MO 64133

800-821-5448

800-844-1199 (fax)

kenwebb@dynamicfastener.com

www.dynamicfastener.com

Dynamic Fastener offers same-day shipping of screws, anchors, flashings, safety equipment, hand tools, and power tools. Available in-house painting of screws and rivets, with one- or two-day lead-time. The company's free 140-page, full color tool and fastener hand guide provides engineering data and details product offering.



East Coast Fasteners

PO Box Q

Elkhart Lake, WI 53020

800-558-5895

800-257-5926 (fax)



kpope@plyco.com

www.plyco.com

East Coast Fasteners is committed to providing the highest quality products and service to the post-frame and commercial construction industries. The company offers a variety of fasteners to deliver the best product for the specific project. East Coast Fasteners produces durable, long-lasting fasteners for all combinations of building materials and is dedicated to producing the highest quality, long-life and fastest drilling products. For assistance in finding the best fasteners for your task, contact a Plyco/ East Coast Fasteners building components professional today.



EDCO Products, Inc.

8700 Excelsior Blvd.

Hopkins, MN 55343

952-945-2674

800-593-2680

sales@edcoproducts.com

www.edcoproducts.com



Energy Panel Structures

603 N. Van Gordon Ave.

Graettinger, IA 51342

800-967-2130

712-859-3275 (fax)

epsmarketing@epsbuildings.com

www.epsbuildings.com

Complete pre-engineered building systems manufactured in Iowa, New York and Missouri for more than 35 years. Systems include: post frame, solid core, livestock, residential, structural insulated panels, and pre-assembled stud walls. Call for your local builder/dealer today!

Englert, Inc.

1200 Amboy Ave.

Perth Amboy, NJ 08861

800-364-5378

732-826-8865 (fax)

info@englertinc.com

www.englertinc.com

EPDM coatings

EPDM Coatings

494 Bridgeport Ave., Ste. 101-342
Shelton, CT 06484
610-298-1989
702-977-2936 (fax)
info@epdmcoatings.com
www.epdmcoatings.com

Fix roof leaks once with Liquid Rubber, the only liquid EPDM in the world. It provides a new roof at a fraction of the cost. With a 25-year history of success, this one-coat application has been proven in laboratory testing to last three times longer than elastomers. Save time and money with a do-it-yourself application. Takes submerged water 365 days a year. Don't forget to ask about volume discounts! EPDM coating was awarded Top 10 Product honors by Metal Roofing Magazine.



Erect-A-Tube, Inc.

PO Box 100
Harvard, IL 60033
815-943-4091
815-943-4095 (fax)
hangars@erect-a-tube.com
www.erect-a-tube.com

Erect-A-Tube Inc. designs, engineers and fabricates electric bi-fold doors, clear-span hangars, and tee-hangars for the general aviation and small business jet markets. All of our products are designed and engineered to your specifications and building code requirements. With 56 years of manufacturing experience, design flexibility and commitment to quality, our products will provide years of reliable service.



Everlast Roofing, Inc.

10 Enterprise Ct.
Lebanon, PA 17042
888-339-0059
717-270-6569 (fax)
info@everlastroofing.com
www.everlastroofing.com

Everlast manufactures a variety of quality, high-performance metal roofing and siding materials for architectural, commercial, industrial, post-frame and residential markets and features a wide range of gauges, colors and custom trims.



Raytec Manufacturing

Hangtite™

Gutter Hanger
with Clip



Hangfast®

Gutter Hanger



REAL® Gutter Cover



FLASHING

Step ■ Apron ■ Roll

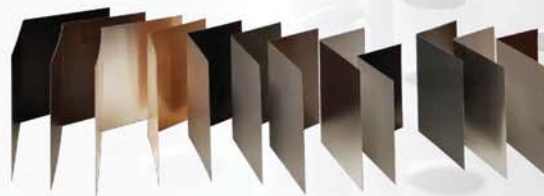

Rezist™



See more at RaytecLLC.com

CALL (877) 800-2500
Email Sales@RaytecLLC.com



Extrutech Plastics, Inc.

5902 W. Custer St.
Manitowoc, WI 54220
920-684-9650
888-818-0118
920-684-4344 (fax)
info@epibp.com
www.epiplastics.com
Extrutech Plastics, Inc. is an ISO 9001 Certified Manufacturer of bright white tongue and groove wall and ceiling panels that are perfect for incidental food contact applications. Panels install quickly with no exposed fasteners, providing a smooth, easy-to-clean surface. Suspended ceiling panels, new concrete FORM System and doors also available.

Fabral

30 Technology Pkwy. S, Suite 400
Norcross, GA 30092
800-477-2741
info@fabral.com
www.fabral.com



Fascut Industries, Inc.

7248 Inama Rd.
Sauk City, WI 53583
608-643-6678
608-643-2682 (fax)
www.fascut.com



Maximizing the Value of Your Building Investment

FBI Buildings, Inc.

3823 W. 1800 S
Remington, IN 47977
800-552-2981
219-261-3193 (fax)
info@fbibuildings.com
www.fbibuildings.com



Filc USA - makers of DRIPSTOP

10118 Settlement House Rd.
Dayton, OH 45458
937-660-6646
937-999-3927 (fax)
info@dripstop.com
www.dripstop.com



DR!PSTOP is the world's best-selling condensation control membrane thanks to being the solution most builders turn to and trust. Builders eliminate the hassle of installing insulation or vapor barriers since DR!PSTOP absorbs moisture as it appears in the building overnight, and releases it as normal humidity during the day. Filc USA is also proud to present Steel Shield, a new residential product that protects the underside of the steel against abrasion during reroofing.



Steel Soffit

Vented or Solid

- Heavy-duty 29 gauge steel.
- Available in all 25 of our standard colors.
- 12" wide coverage by 11.5" in-stock.
- Custom overhang lengths available from 1.5" to 48'.

**In-stock for
Fast Shipment Nationwide**

82 Garden Spot Rd. | Ephrata, PA 17522 | 717-445-6885
35 Ridge Rd. | Newville, PA 17241 | 717-776-5951 www.abmartin.net

Circle Reader Service #291



**The Affordable Rollforming
Equipment Manufacturer**

Metal Rollforming Systems designs and manufactures reliable and affordable rollforming equipment and accessories, making us a leader in rollforming equipment manufacturing. Our unsurpassed technical support is unlike any other in the industry, we work until the job is done. Our customer's success is our success. For more information, please contact us at 509.822.8123 or visit us online.

- Single & Double Deck Rollformers
- Trim Rollformers
- *NEW* Patriot Rollforming Line
- Coil Reels
- Precision Cut Slitting Lines
- Sheet Stackers
- Coil Upenders
- Ridge-Cap Press



509.822.2123 www.mrsrollform.com

Circle Reader Service #584

FRAME BUILDING NEWS

Frame Building News

PO Box 255
Iola, WI 54945
715-252-6360 (Gary)
www.constructionmagnet.com

Frame Building News has been devoted exclusively to coverage of the post-frame construction industry for the past 30 years. It has more than 19,000 subscribers, most of which make their living in the post-frame industry. It is published five times a year. For editorial questions contact Karen@shieldwallmedia.com. For advertising opportunities contact Gary@shieldwallmedia.com.

Garland Company, The

3800 E. 91st St.
Cleveland, OH 44105
800-321-9336
216-641-0633 (fax)
info@garlandind.com
www.garlandco.com



Graber Post Buildings

7716 N. 900 E.
Montgomery, IN 47558
800-264-5013
812-636-4936 (fax)
trent@graberpost.com
www.graberpost.com

Graber Post Buildings, Inc. is a leading manufacturer and supplier of post-frame building products. We specialize in complete building material kits that can be packaged and delivered direct to your job site with the ease of a phone call. Before your next project give us a call or visit us online.



GSSI Sealants, Inc.

1420 N. Post Oak Rd.
Houston, TX 77055
800-288-9489
888-947-4925 (fax)
info@gssisealants.com
www.gssisealants.com

GSSI Sealants, Inc. is an independent, family-owned manufacturer of premiere elastomeric butyl rubber sealant tapes. We have been producing tapes for a wide range of industries and applications for more than 30 years. Our MB-10A is a premier elastomeric butyl rubber sealant designed to meet the critical requirements of metal building applications.



Double and Single Sheet Metal **Folding Machines**



- » European engineering and American manufacturing; get the best of both worlds!
- » Servo drive technology; highest precision and speed at minimum noise level!
- » Widen the bottleneck in your trim operation with the new Slit-Frei 2-way post cut slitter!



420 PROGRESS DR MATTOON, IL 61938
TOLL FREE: (877) 289-3030
INFO@HERSHEYSMM.COM

Speed. Accuracy. Service.

Don't just bend trim- Variobend it! Call today!

Circle Reader Service #536

THE EDUCATION PROGRAMMING INCLUDES:

- Inventory control and management
- Improving quality and productivity
- Coil and steel metallurgy and properties
- Paint and coating technology
- Business best practices and development
- More sessions to be added

SPECIAL PRESENTATION:

Friday, December 13, focusing on industry metrics on roll forming in the construction industry and its potential for growth.

ADMISSION:

Trade Show Admission: \$45

Trade Show Admission + Education Sessions: \$150.

REGISTER NOW:

www.constructionmagnet.com/construction-rollforming-registration
ONLINE REGISTRATION CLOSES NOVEMBER 22nd

UPCOMING ISSUE

RURAL BUILDER MAGAZINE

From the publishers of *Metal Roofing Magazine*, *Frame Building News* and *Rollforming Magazine*.

Rural Builder provides the news, features, products and how-to's geared towards builders and suppliers of primarily low-rise agricultural and small retail and municipal structures.

DECEMBER

- Cover Story: Promoting Your Business Through Social Media
- Product Feature/Profiles: Ventilation/Insulation
- Project of the Month
- Advertising Deadline: **Nov. 18, 2019**



TO SUBSCRIBE, VISIT: www.constructionmagnet.com/subscribe

For more information contact: Gary Reichert at gary@shieldwallmedia.com 715-252-6360



GutterBrush Gutter Guard

855 Aquidneck Ave. #6
Middletown, RI 02842
888-397-9433
info@gutterbrush.com
www.gutterbrush.com

Contractors' simple solution to keep gutters flowing. No tools, cutting or fasteners needed. Self fitting and available for a 3.25" - 8" gutters. Easiest insulation and maintenance. No need to spend thousands on gutter guards. Contractor discounts and some samples available. Proudly Made in U.S.A.



GutterSupply.com

19 Skokie Valley Rd.
Lake Bluff, IL 60044
888-909-7246
847-283-0007 (fax)
info@guttersupply.com
www.GutterSupply.com
GutterSupply.com is a supplier and manufacturer of gutters and gutter accessories in aluminum, copper, steel, Galvalume, zinc and Freedom Gray Copper. Product line includes gutter guards, gutter machines, rain chains, snow guards, portable brakes and a large selection of custom-made products.

H&H Metal Products

104 Industrial Way
Charlestown, IN 47111
812-256-0444
812-256-0465 (fax)
contacthh@hhmetalproducts.com
www.hhmetalproducts.com



Hayes International

1200 E. Cole St.
Moundridge, KS 67107
620-345-6394
620-345-6381 (fax)
bradbury@bradburygroup.com
www.bradburygroup.com
Hayes International specializes in the design and manufacture of roll-forming machinery for the production of roofing and wall cladding profiles, structural sections such as CEE and ZEE purlin, and a wide variety of associated metalworking equipment.

Heritage Equine Equipment

74 Quail Ln.
Box Springs, GA 31801
706-575-5153
800-314-0656
marybeth@heritageequineequip.com
www.heritageequineequip.com



Design. Manufacture. Erect.

Free "Building Blocks of Self Storage" seminars coming in 2020:

Louisville, KY
January 30

Kalamazoo, MI
February 11

Charlotte, NC
February 13

Denver, CO
March 3



2013 - 2019
BEST OF BUSINESS
BEST BUILDING COMPONENTS



800 356-5824 ■ trachte.com

Circle Reader Service #559



Hershey's Metal Meister

420 Progress Dr.
Mattoon, IL 61938
877-289-3030
217-234-4702 (fax)
info@hersheysmm.com



Discover the advantages of the Variobend USA folding machine! A unique hybrid of European design and American manufacturing; get the best of both worlds! Need parts? No need to look beyond the massive parts inventory at Hershey's! Call today to see how we can help you succeed!

Hi-Fold Door Corporation

N6170 1070th St.
River Falls, WI 54022
800-443-6536
715-262-3998 (fax)
sales@hi-fold.com
www.hi-fold.com

Homework Design, Inc./Plasti-Sleeve

26740 Hwy. 169
Zimmerman, MN 55398
763-856-5555
763-856-2975 (fax)
sales@plastisleeve.com
www.plastisleeve.com

Hörmann, LLC

5050 Baseline Rd.
Montgomery, IL 60538
630-859-3000
630-859-8122 (fax)
info@hormann.us
www.hormann.us

Hoskins Mfg. Co., Inc.

PO Box 101
105 N. Main St.
Hoskins, NE 68740
402-565-4420
402-565-4529 (fax)
hoskmfg@ptcnet.net
www.hoskins-mfg.com

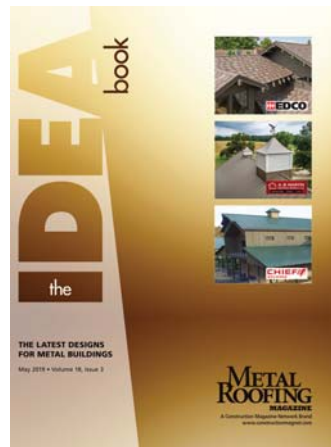

METAL ROOFING the idea book
MAGAZINE

Idea Book, The

PO Box 255
Iola, WI 54945
715-252-6360 (Gary)
www.constructionmagnet.com
Featuring signature projects of the metal roofing manufacturers that showcase the best of metal design and architecture. For editorial questions contact Sharon@shield-wallmedia.com. For advertising opportunities contact Gary@shieldwallmedia.com.



Indiana Warm Floors, Inc.

935N 275W Suite B
Angola, IN 46703
260-668-8836
260-668-8839 (fax)
scott@indianawarmfloors.com
www.indianawarmfloors.com
Radiant heat systems from Indiana Warm Floors are green energy options for heated pole barns, farm buildings, home floors, heated driveways, patios and loading docks, with potential energy savings up to 70 percent. Indiana Warm Floors, serving Northern Indiana, Ohio and Michigan, offers radiant floor heat, geo-thermal heating and cooling systems, snowmelt systems, (IR) tube heat and tankless water heaters. Indiana Warm Floors has been an authority in green energy since 1979.



International Roofing Expo

6191 N. Hwy. 161, Suite 500
Irving, TX 75038
800-684-5761
972-536-6410 (fax)
info@theroofingexpo.com
www.theroofingexpo.com

Taking place February, 4-6, 2020 at the Kay Bailey Hutchison, Dallas, Texas, the International Roofing Expo (IRE) is the preeminent roofing construction and maintenance event where roofing professionals experience face-to-face interaction, product review, education and networking. The expansive show floor and extensive educational program provide the best opportunity to discover the latest trends, advances in technology and best practices for business growth.



Kennedy Insulation Group

16800 Fir Rd.
Carthage, MO 64836
417-358-4580
Rick@kennedyinsulationgroup.com
www.kennedyinsulationgroup.com
Reflective Insulation is all that we do! Versola brand insulation is produced right here in the USA in our Midwest facility. Industry experts were consulted to ensure that we add the highest levels of preventative components to safeguard against deterioration and degradation in our products. Our facility boasts a dedicated state-of-art bubble lamination machine to produce seamless rolls up to 6' in width. Versola Reflective Insulation is our primary product. RIMA verified.

Klauer Manufacturing, Co.

1185 Roosevelt St. Extension
Dubuque, IA 52001
563-582-7201
563-582-2022 (fax)
sales@klauer.com
www.klauer.com

KYNARAQUATEC®

BY ARKEMA

Kynar Aquatec

900 First Ave.
King of Prussia, PA 19406
610-205-7874
ron.partridge@arkema.com
www.kynaraquatec.com
Kynar Aquatec® PVDF latex is formulated into water-based, metal restoration coatings that provide the durability and performance of traditional Kynar 500® resin based coatings. Now the extreme weatherability of a Kynar 500® resin based coating is available in a VOC compliant, field or factory applied ambient air dry system with tremendous resistance to dirt pick-up, outstanding water repellency and high initial and long term Total Solar Reflectance and Emissivity.



Leland Industries

95 Commander Blvd.
Toronto, ON M1S 3S9
800-263-3393
416-291-0305 (fax)
info@lelandindustries.com
www.lelandindustries.com
Leland domestically manufactures a complete line of fasteners for wood frame, metal roofing and steel frame projects. The company offers self-tapping and self-drilling sealing fasteners in lengths up to 8-inches, #10, 12 and 14 diameter. Leland's fasteners are 100% North American Made, in carbon steel or stainless steel that can be plated, coated or powder coated to match any panel color. Leland will match any steel painted panel warranty without exception.



Lester Building Systems, LLC

1111 2nd Ave. South

Lester Prairie, MN 55354
800-826-4439
www.lesterbuildings.com



Levi's Building Components

137 Newport Rd.
Leola, PA 17540
877-897-7020
717-656-2558 (fax)
info@levisbuildingcomponents.com
www.levisbuildingcomponents.com
Levi's Building Components can consolidate your roofing accessory orders. Known for quality products, quick shipping and expertly-filled orders, Levi's is a wholesale supplier and one stop for all your metal building fastener and accessory needs. Check out our extensive line of fasteners, including Fastgrip screws and our variety of snow retention guards, both available in 40-plus colors. Find roofing underlayment, venting, sealing and more.



CLASSIC DOOR

FEATURES:

- Full 1-3/4" thick panel w/ 26-gauge skin
- Exclusive inner lock design
- All steel frame - all steel skin, pre-hung
- Frame has common header/threshold
- Nylon lockset insert eliminates loosening
- Fixed-pin hinges
- Pre-finished frame with dual contact weatherstrip



1035 PLEASANT ST. STE C
BELOIT, WI 53511
P. 800.766.2825 • F. 800.834.7447
www.CNBHNP.com

1200-SERIES VINYL WINDOW

FEATURES:

- All fusion welded PVC construction
- Insulated glass with warm edge spacer
- 2-5/8" multi-chamber frame
- 7/8" insulated glazing
- Cam lock and keeper provides maximum security and weather sealing
- Now available with snap-in J-channel



Circle Reader Service #386

CAUTION

DO NOT READ THIS. CAUTION

DON'T EVEN LOOK UNLESS YOU'RE A RURAL BUILDING PRO!

We're only looking for professionals working in the rural construction industry because that's all we are about. Each issue of *Rural Builder & Frame Building News* magazine delivers news and information created expressly for the rural construction industry. Post-frame building isn't a topic that we "cover" a couple of times a year. It's our focus in every issue so if you're not building, repairing or replacing rural buildings there's no reason for you to subscribe.

If you are a rural construction professional, these magazines are a resource you can use to help build your business. Every issue will help you and your team stay abreast of the latest products and components for the work you're doing. You'll also read about the best practices leading contractors are using to improve their productivity and profitability. Plus, a lot more! The best part about these magazines is that they are all free if you're a rural building professional. **To subscribe, go to www.constructionmagnet.com/subscribe.**



**Rural
Builder**

**FRAME
BUILDING
NEWS**



Roofing Ventilation & Accessories

Marco Industries

4150 S. 100th E. Ave., Suite 301
Tulsa, OK 74146
800-800-8590
918-622-4536 (fax)
info@marcoindustries.com
www.marcoindustries.com



We make the best roofing ventilation and accessories for metal roofs — period. With the most tested and certified products on the market, you can trust our solutions to perform in even the harshest conditions, protecting your roof and everything underneath. Only Marco offers the Weather-Tite System, a comprehensive line of metal roofing solutions that offer easy installation, remarkable building ventilation, lower utility costs, extreme durability and outstanding warranties. If it's not proven, it's not Marco.

Marion Manufacturing, Inc.

201 S. Coble St.
Marion, KS 66861
888-865-8740
620-382-2322 (fax)
sales@marionmanufacturing.com
www.marionmanufacturing.com

**Maze Nails**

100 Church St.
Peru, IL 61354
800-435-5949
815-223-7585 (fax)
kim@mazenails.com
www.mazenails.com



Maze offers a full line of specialty nails in bulk for hand driving and in collated sticks and coils for pneumatic nailers. Maze Nails is the exclusive manufacturer of STORMGUARD® Double Hot-Dipped

Galvanized Nails with a LIFETIME WARRANTY against rust. Maze has been serving the post-frame industry for many years, providing rubber washer nails, gutter spikes, joist hanger nails, hardened and threaded post-frame nails, roofing and siding nails. Call for more information or free samples.

MBCI

14031 W. Hardy St.
Houston, TX 77060
877-713-6224
info@mbci.com
www.mbci.com

**McElroy Metal**

1500 Hamilton Rd.
Bossier City, LA 71111
800-562-3576
318-747-8059 (fax)
info@mcelroymetal.com
www.mcelroymetal.com



mwicomponents.com | 800.360.6467



The horses got together and took a vote. MWI is now rated #1 by the equine community.

Circle Reader Service #308



Metal Construction Association

8735 W. Higgins Rd., Suite 300
Chicago, IL 60631
847-375-4718
847-375-6488 (fax)
mca@metalconstruction.org
www.metalconstruction.org

METALCON 2020

10 Midland Ave.
Newton, MA 02458
617-965-0055
617-965-5152 (fax)
lismany@metalcon.com
www.metalcon.com
Oct. 21-23, 2020
Las Vegas, Nevada



Metal Panels, Inc.

131 S. 147th E. Ave.
Tulsa, OK 74116
918-641-0641
918-641-0640 (fax)
contact@metalpanelsinc.com
www.metalpanelsinc.com
Metal Panels Inc. manufactures quality metal roofing and siding products and has been meeting the needs of the metal roofing, metal building, and post-frame industries since 2001. MPI offers 18 panel profiles, including standing seam, through-fastener and curved panels, as well as custom trim up to 21 feet. For metal roofing, metal building supplies and accessories, MPI is your single-source supplier.



Metal Rollforming Systems

4511 N. Freya St.
Spokane, WA 99217
833-284-6794
509-467-5631 (fax)
info@mrsrollform.com
www.mrsrollform.com

Metal Rollforming Systems manufactures and sells the highest quality American-made roll-forming equipment and accessories available at prices that cannot be beat. With 26 years in business and more than 50 different product lines, including panel roll formers, trim roll formers, slitters, upenders, profiled shears and more. MRS has the equipment, knowledge and support to help you and your business be successful.



Metal Roofing Magazine

PO Box 255
Iola, WI 54945
715-252-6360 (Gary)
www.constructionmagnet.com
Metal Roofing Magazine started as a supplement to Rural Builder, but quickly blossomed into its own publication with the growth of metal roofing. Within the pages of Metal Roofing, readers discover projects and products relevant to their industry and business. Metal Roofing Magazine is published seven times a year and is geared toward the professional metal roofer, with tips, features, news and product profiles. For editorial questions contact Sharon@shieldwallmedia.com. For advertising opportunities contact Gary@shieldwallmedia.com.



MFM Building Products

525 Orange St.
Coshocton, OH 43812
800-882-7663
740-622-6161 (fax)
info@mfmbsp.com
www.mfmbsp.com



MFM Building Products manufactures a complete line of exterior, self-adhering waterproofing membranes. Product line includes low-slope roofing membranes, roofing underlays, window flashing tapes, above- and below-grade waterproofing membranes and specialty construction tapes. Request your FREE sample by visiting the website.



Midland Door Solutions

1021 7th Street NE
West Fargo, ND 58078
800-921-7008

701-277-8961 (fax)
info@midlanddoorsolutions.com
www.midlanddoorsolutions.com
Midland Door Solutions (formerly Midland Bi-Fold Doors) is the unparalleled leader in the design, manufacturing and installation of custom bi-fold and hydraulic doors. Since 1995, Midland has been providing solutions to customers' big door needs. We guarantee the best customer service and lowest total cost of ownership within the industry.



Midwest Enterprises

PO Box 188, #1 Wagner
Saint Clair, MO 63077
800-748-7736
636-629-3177 (fax)
sales@e-zgutter.com
www.e-zgutter.com
Midwest Enterprises manufactures E-Z Gutter Guards, a wide variety of painted, brushed aluminum, powder coated and copper gutter protection. E-Z Gutter Guards are available nationwide through a wide network of distributors. Engineered for higher performance under heavy rain and wind, E-Z Gutter Guards are the hardest working gutter guards in the business.

Midwest Perma-Column

7407 N. Kickapoo Edwards Rd.
Edwards, IL 61528
800-798-5562
309-589-1199 (fax)
info@midwestpermacolumn.com
www.midwestpermacolumn.com

Morton Buildings

252 W. Adams St.
Morton, IL 61550
800-447-7436
info@mortonbuildings.com
www.mortonbuildings.com



MWI Components

1015 32nd Ave. West
Spencer, IA 51301
800-360-6467
712-262-8944 (fax)
contactsales@mwicomponents.com



www.mwiccomponents.com

MWI Components is a leading manufacturer/supplier of post-frame products — offering more color options than anyone else in the industry. With over 100 colors available in steel, almost 30 different aluminum colors, and 50-plus powder coat colors, the combinations are endless. Create beautiful, unique buildings with our cupolas, ridge-vents, soffit, trim, round/square track & accessories, and stall systems. Complete your building's aesthetic with our Dutch, bale, or Arcadian sliding doors. Call MWI Components today or visit our new website to make your buildings stand out from the rest!

Nationwide Protective Coating Mfrs., Inc.

7106 24th Court East
Sarasota, FL 34243
800-423-7264
941-753-1773 (fax)
info@natcoat.net
www.nationwidecoatings.com



New Tech Machinery

A MAZZELLA COMPANY

New Tech Machinery Corp.

1300 40th St.
Denver, CO 80205
800-574-1717
303-294-9407 (fax)
sales@newtechmachinery.com
www.newtechmachinery.com
New Tech Machinery manufactures the world's finest portable roof panel and gutter machines. Located in Colorado, we have distributors worldwide and our equipment has been shipped to more than 40 different countries. We offer innovation, high quality equipment and unmatched customer service.



High Performance Insulation

NOFP, Inc.

725 Enterprise Ave.
Wauseon, OH 43567
800-339-4850
419-335-2380 (fax)
jb@nofp.com
www.nofp.com



Paint Valley Parts / Acu-Form

10550 Township Rd. 262
Millersburg, OH 44654
330-674-4003

330-674-4035 (fax)
acu-form@safecommail.com
Acu-Form has been successful in designing and manufacturing machines that consistently provide quality products using D2 tool steel-forming dies, which provide longevity. Most parts are built in-house, giving us superior quality control. Acu-Form machines can be set up to run with electric, hydraulic or mechanical.

Fade Resistant Protected Over/Under Head



Powder coating outperforms wet paint in resistance to corrosion, chemicals, heat, impact, abrasion, UV rays and extreme weather conditions. Wet paint fades, Powderful coating matches metal panels for decades. The wet paint process emits 1000's of lbs. of harmful VOCs daily, but the Powderful coating process releases none.



No Red Rust Molded Not A Cap

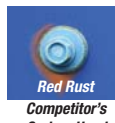

The industry's most corrosive resistant die-cast molded integral cupped head combines a fade resistant Powderful coating with the guaranteed not to RED RUST properties of ZAMAC. Cupped head maintains a positive seal at any angle. No RED RUST is a value both you and your customer can see. Better looking buildings make for better sales.

Reduce Strip Out Grips Soft Fibers

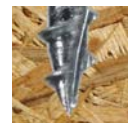

The STRIP LOC thread design resists the expansion & contraction that is found in metal roofing applications keeping the metal panels securely fastened to the OSB. The strength of the STRIP LOC thread design greatly reduces the potential for fastener strip out in OSB, enabling the full pullout value to be realized, thus protecting your valuable metal panel investment.

CALL TODAY 1-800-352-4864



©2019 ST Fastening Systems, a division of The Hillman Group, Inc dba ST Fastening Systems.

Circle Reader Service #429



Palram Americas

9735 Commerce Cir.
Kutztown, PA 19530
800-999-9459
610-285-9928 (fax)
sales.usa@palram.com
www.palramamericas.com

Palram Americas, manufacturer of PVC and polycarbonate panels, has MetalMatch technology, allowing the use of Sunsky® polycarbonate panels for daylighting options with virtually any metal profile available. Palram also offers AG-TUF™ and DURACLAD™ durable PVC liner panels for use in agricultural buildings with excellent resistance to chemicals.



Perma-Column LLC

400 Carol Ann Ln.
Ossian, IN 46777
260-622-7190
sales@permacolumn.com
www.permacolumn.com

Since 2002, Perma-Column has become a leading supplier for alternative foundations in post-frame construction. Perma-Columns are precast concrete piers that fasten to any post or wood column, allowing post frame with no concrete trucks, and no treated wood in the ground. If a poured concrete foundation is preferred, the Sturdi-Wall product is the answer. These heavy-duty brackets come in wet- and drill-set variations to fit most common sizes. All products are engineered and manufactured in the USA.



Petersen Aluminum Corp.

1005 Tonne Rd.
Elk Grove Village, IL 60007
800-PAC-CLAD
800-722-7150 (fax)
sales@petersenmail.com
PAC-CLAD.com

For more than 50 years, Petersen has

provided the highest-quality architectural metal products with reliable lead times. Our products include standing seam and exposed fastener roofing panels, metal wall and soffit panels, composite panels, column covers, perimeter roof edge systems, aluminum and steel coil, and flat stock in painted, anodized and mill finish. See our complete catalog and suite of helpful E-tools on our website.



Plyco Corporation

PO Box Q
Elkhart Lake, WI 53020
800-558-5895
800-257-5926 (fax)
kpope@plyco.com
www.plyco.com

Since 1951, Plyco has been a leading supplier of products to the post-frame, metal-frame and commercial construction industries. Plyco manufactures a full line of products including metal walk doors, windows, horse stall systems, ventilation products, fasteners and closures. For many builders Plyco provides one-stop shopping for their building component needs.



Post Protector

PO Box 187
Pottsville, PA 17901
570-624-7030
570-624-7031 (fax)
ken@postprotector.com
www.postprotector.com
EVERYONE knows that wood in 'ground-contact' is NOT the optimum environment for maximum longevity performance. The attractive, easy-to-install, slide-on Post Protector and snap-on 'compression fit' Skirt-Board Protector retain the speed, simplicity, affordability, and strength that IS traditional post frame, while eliminating ALL ground-contact. Brilliant! Builders who offer their customers the option for Post Protector products say an impressive 60-70% purchase this sensible foundation protection system. While others prudently make the system standard so that every customer benefits from this obvious and substantial foundation improvement!



PowerLift Hydraulic Doors

PO Box 311
Lake Benton, MN 56149
507-368-9500
507-368-1358 (fax)
info@powerliftdoors.com
www.powerliftdoors.com

PowerLift Hydraulic Doors has over 27 continuous years of proven performance and superior customer service. Beyond PowerLift's experience, our philosophy revolves around three customer-oriented principles: Quality, Reliability, and Local Service. PowerLift supplies hydraulic doors and opening walls for a diverse customer base including the agriculture, aviation, commercial and residential markets.



Prassas Metal Products, Inc.

1411 W. 190th St., Suite 360
Gardena, CA 90248
310-217-4533
800-294-3427
pmpsteel@yahoo.com
www.pmpsteel.com

PMP Steel is a 29-year-old steel trading and coated coil distributor, specializing in Pre-painted Galvalume, Acrylic Galvalume, and Galvanized coil products. PMP supplies competitively priced import and domestic mill products to all major USA markets and a wide variety of industry applications, such as residential roofing, metal buildings, and garage door. PMP Steel maintains coil distribution centers at Savannah, Georgia, and Tampa, Florida, stocking a full line-up of industry-standard colors for ValsparXL, Akzo1050, and our Generic 40-year "Cool" SMP colors. In addition, we provide 20 colors of 29 ga x Regular Polyester PPGL and a full range of AZ55/Acrylic Galvalume coil (29 ga - 22 ga) for the metal building industry.



RAMCO Supply

4572 N. Old US Hwy. 31
Rochester, IN 46975
574-223-7802
574-223-7846 (fax)
marvin@ramcosupply.com
www.ramcosupply.com
Ramco Supply manufactures metal sid-

ing and roofing for pole barns and house roofs. Ram Panel is a 28 gauge 36 inch wide panel with 3/4-inch high ribs. Ramco Supply also manufactures standing seam roofs in 16-inch wide panels. Ramco Supply sells windows, doors, sliding door track, and lumber. Ramco Supply offers complete building packages.



Raytec Manufacturing

544 Gristmill Rd.
Ephrata, PA 17522
877-800-2500
717-445-0511 (fax)
sales@raytecllc.com
www.raytecllc.com

Raytec has been serving the rain gutter industry since 1956. Manufacturers of Hangtite and Hangfast hidden gutter hangers, the company is committed to exceeding your quality and customer service expectations. East Coast, Midwest and Northwest warehouses ensure fast deliveries. Most orders ship in 24 hours.



Reflectix, Inc.

#1 School St.
Markleville, IN 46056
800-879-3645
765-533-2327 (fax)
steve.ray@reflectixinc.com
www.reflectixinc.com



Replications Unlimited, LLC

9200 Latty Ave.
Hazelwood, MO 63042
314-524-2040
314-524-4040 (fax)
sales@replicationsunlimited.com
www.replicationsunlimited.com
Replications Unlimited manufactures an innovation series of pre-engineered stone, brick and wood panels designed for the metal building industry. Also visit www.urestonepanels.com.



Rigidply Rafters, Inc.

701 E. Linden St.
Richland, PA 17087
717-866-6581
717-866-7237 (fax)



www.rigidply.com

Rigidply Rafters has improved the quality of post-frame buildings by manufacturing and distributing the original 100 percent glue-laminated post. By specifying Rigidply Posts, you guarantee the labor saving and quality advantages of true glulam posts. Not only are glulam posts lighter, straighter, and stronger than solid sawn posts, but they minimize cracking and splitting. When planning your next building project, count on Rigidply Rafters to supply integrity, quality and service with your glulam posts.



Roll Former Corporation

140 Independence Ln.
Chalfont, PA 18914
215-997-2511
215-997-5544 (fax)
jdumke@rollformercorp.com
www.rollformercorp.com

Roll Former Corporation offers the most productive and cost effective roll forming equipment for the metal roofing and architectural sheet metal industries. Since 1978 we have been leading the industry with our innovation and service.

Building Quality Every Time

You won't compromise on the quality you deliver to your customer. Your building partner shouldn't compromise on the designs, materials or service they deliver to you.

Buildings with quality and value...and no compromises. Join our team!

800-356-9682
WickBuildings.com



Agriculture ■ Suburban ■ Equestrian ■ Commercial

Circle Reader Service #511

Rollforming Magazine

Rollforming Magazine

PO Box 255
Iola, WI 54945
715-252-6360 (Gary)
www.constructionmagnet.com
From the publishers of Rural Builder, Metal Roofing Magazine and Frame Building News. Launched in Fall 2018, Rollforming Magazine is the only publication specifically geared to roll formers in the construction industry. The magazine mails to subscribers, four times annually: Winter, Spring, Summer and Fall. For advertising opportunities contact gary@shieldwallmedia.com. For editorial questions contact sharon@shieldwallmedia.com.

Rural Builder

Rural Builder

PO Box 255
Iola, WI 54945
715-252-6360 (Gary)
www.constructionmagnet.com
Rural Builder provides the news, features, products and how-to's geared towards builders and suppliers of primarily low-rise agricultural, small retail, municipal and residential structures. Published eight times annually, Rural Builder serves a horizontal market targeting all types of low-rise construction in cities of 250,000 or less population. For editorial questions contact karen@shieldwallmedia.com. For advertising opportunities contact gary@shieldwallmedia.com.



RUSTGO Mobile Work Platforms

405 Valley Lake Drive
Birmingham, AL 35206
800-448-4077
205-838-8441 (fax)
williamking@rustgousa.com
www.rustgousa.com
We are the National Representative for RUSTGO All-Terrain Mobile Work Platforms. Our representation of the Rustgo

Product line has been for more than 28 years. We are Rustgo Product Specialists in Rustgo Unit sales as well as Rustgo Parts Sales.

S-5!

8750 Walker Rd.
Colorado Springs, CO 80908
719-495-0518
888-825-3432
719-465-0045 (fax)
info@s-5.com
www.s-5.com



Safe-Way Garage Doors, LLC

3814 E. US 30
Warsaw, IN 46580
574-267-4861
574-267-2871 (fax)
bthompson@safewaydoor.com
www.safewaydoor.com
Safe-Way Door is a leading manufacturer of quality residential, commercial and industrial overhead garage doors in steel, wood and aluminum. Headquartered in Warsaw, Indiana, Safe-Way Door also operates facilities in Tennessee and Missouri with distribution throughout North America and Canada. Doors are available in multiple configurations including polyurethane and polystyrene insulated, un-insulated and up to 11 colors in steel, and multiple powder coat colors in aluminum. Commercial door sizes are available in all of the panel designs. Safe-Way also sells residential and commercial openings and other door-related accessories.



Schweiss Doors

PO Box 220
Fairfax, MN 55332
507-426-8273
507-426-7408 (fax)
schweiss@schweissdoors.com
www.schweissdoors.com
Schweiss One-Piece hydraulic doors set the standard for hydraulic doors on the market. Fast moving hydraulic doors have the Powerful Red Power pump, bigger cylinders and are easy to install. Schweiss bifold doors with fast moving lift-straps are another high-quality, reliable Schweiss door. Schweiss manufactures the best doors on the market and has since 1980.

SFS

1045 Spring St.
Wyomissing, PA 19610
610-376-5751
610-376-8551 (fax)
us.construction@sfsintec.biz
www.sfsintecusa.com
SFS is the premier manufacturer and supplier of fasteners for post frame and metal building industries. Our wood screws and self-drill fasteners in a variety of materials, thread styles and point geometries meet the requirements and demands of today's buildings. The ConnexTite™ structural wood screw is ideal for single and multi-ply truss, column header and joist applications. Accessories include VistaVent™ ridge ventilation, VistaFoam™ closures, tapes and sealants, and pipe flashing, making SFS a one-source supplier for metal panel attachment solutions.

SHERWIN-WILLIAMS. Coil Coatings

Sherwin-Williams Coil Coatings

701 S Shiloh Rd.
Garland, TX 75042
888-306-2645
coilhelp@sherwin.com
www.coil.sherwin.com
Sherwin-Williams Coil Coatings (formerly Valspar) has been a leader in the art and science of coatings that excel in both beauty and function. Our expansive range of superior quality coatings comes to life through a full palette of colors and textures to meet the most demanding environmental conditions and designs.



Silvercraft

11520 CR18
Middlebury, IN 46540
574-825-8757
574-825-0009 (fax)
silvercraftsales@safecommail.com
Silvercraft is the home of pre-assembled aluminum Dutch and sliding doors. These premium doors are available for any equine facility or hobby building. Silvercraft also manufactures bifold doors, walk doors, and other products for the poultry and agricultural building industries.

Snap-Z

330 Swamp Rd.
Morgantown, PA 19543
406-781-0615
info@standingseamroofvent.com
www.standingseamroofvent.com

Source Book, The

PO Box 255
 Iola, WI 54945
 715-252-6360 (Gary)
 www.constructionmagnet.com
 Cutting edge ideas and inspiration for rural builders. For editorial questions contact karen@shieldwallmedia.com. For advertising opportunities contact gary@shieldwallmedia.com.

Spin Screed

5032 College Avenue, Suite B6
 Quincy, IL 2305
 888-329-6039
 info@spinscreed.com
 www.spinscreed.com



ST Fastening Systems
 6357 Reynolds Rd.
 Tyler, TX 75708



800-352-4864
 800-352-3940 (fax)
 dquehl@stfastening.com
 www.stfasteningsystems.com
 ST Fastening Systems manufactures steel-frame and post-frame fasteners for agricultural, industrial, commercial and residential metal roof and sidewall applications. Product strengths are drill point quality and corrosion resistance, as shown by the WOODBINDER MB drill point and ZXL zinc-aluminum alloy molded head. Both are enhanced by a powder coating paint system. Solid and vented closure strip systems, pipe flashings, and other accessories round out the product line.



Starwood Rafters, Inc.
 W24141 Starwood Ln.
 Independence, WI 54747
 888-525-5878
 715-985-5222 (fax)
 lamply@triwest.net
 www.starwoodrafters.com

Starwood Rafters' laminated wood products include Lam-Ply Truss, the company's most popular product. It combines plywood with glulams and dimensional lumber for stronger trusses that can be spaced farther apart. It can be used in many applications.



Steel Dynamics, Inc.
 4500 Co. Rd. 59
 Butler, IN 46721
 800-799-8942
 260-868-8202 (fax)
 brian.smallwood@steeldynamics.com
 www.stld.com



Steel Dynamics is a leader in the production of high-quality, low-cost, pre-painted steel for the metal construction industry. Its wide width, light-gauge, pre-painted flat-rolled steel is perfectly suited for roof, wall and fascia systems used in the construction of metal structures. Also, SDI's state-of-the-art pre-paint lines run parallel to its galvanized and Galvalume lines, reducing transportation costs and shortening the supply cycle...and that saves time, reduces inventory, and increases working capital.

Circle Reader Service #288

LEADING QUALITY. BY TRADITION.

With more than 50 years of experience in the development and production of high quality air-driven fastening tools, we offer a broad range of leading quality tools. More than 100 different models of staplers, nailers and specialty tools, all designed to ease your workload. FASCO® air driven tools are engineered to deliver the uncompromising performance and power required by pros. To learn more, visit www.fasco-tools.com

FASCO®, GEAR UP FOR THE PERFECT JOB.

BECK America Inc. | 800-239-8665 | www.beck-america.com

Circle Reader Service #359



Sukup Manufacturing, Co.

1555 25th St., Box 677
 Sheffield, IA 50475-0677
 641-892-4222
 641-892-4629 (fax)
 info@sukup.com
 www.sukup.com

Sukup Manufacturing Co.'s pre-engineered steel buildings feature clear-span construction and standing seam or screw-down roofs. The clear-span design allows for flexibility in customizing interior space to meet customer needs. Purlins and girts are galvanized for long life and pre-punched to ensure proper fit and faster installation. A variety of sidewall and trim colors and options are available.



Swenson Shear

4257 E. Keyes Rd.
 Ceres, CA 95307
 877-588-8748
 209-667-8427 (fax)
 sales@swensonshear.com
 www.swensonshear.com

The Snap Table is the all-in-one panel preparation system for standing seam metal roofing, with the highest quality in notching, slitting and hemming. The Snap Table PRO provides up to a 60 inch slit and hem on panels 12 to 24 inches wide. We also have shears for exposed fastener panels.



TAPE Products Company

Tape Products Company
 11630 Deerfield Rd.

Cincinnati, OH 45242

513-489-8840

513-489-4616 (fax)

customerservice@tapeproducts.com

www.tpcpackagingsolutions.com

Servicing customers since 1967 with pressure sensitive tapes (including duct, stucco, sheathing and seaming tapes), reflective insulation and barrier films for post frame, metal building and construction. Also available are stretch wrap and equipment for heavy duty applications, including horizontal wrappers for long, heavy loads. Distribution centers are located in Cincinnati, Dallas, Orlando and Chicago.



Trac-Rite Door

314 Wilburn Rd.
 Sun Prairie, WI 53590
 800-448-8979
 608-825-6745 (fax)
 tr@tracrite.com
 www.tracrite.com

Trac-Rite Door manufactures quality steel roll-up doors for a multitude of uses includ-

STATEMENT OF OWNERSHIP, MANAGEMENT AND CIRCULATION (required by Act of August 12, 1970: Section 3685, Title 39, United States Code). 1. RURAL BUILDER. 2. (ISSN: 0888-3025) 3. Filing date: 10/1/19. 4. Issue frequency: 8 issues annually. 5. Number of issues published annually: 8. 6. The annual subscription price is 29.98. 7. Complete mailing address of known office of publication: Shieldwall Media LLC 1990 Godfrey Dr Waupaca WI 54981. Managing Editor: N/A. 10. Owner: Shieldwall Media 1990 Godfrey Dr Waupaca WI 54981. 11. Known bondholders, mortgages, and other security holders owning or holding 1 percent or more of total amount of bonds, mortgages or other securities: None. 12. Tax status: Has Not Changed During Preceding 12 Months. 13. Publisher title: RURAL BUILDER. 14. Issue date for circulation data below: SEPTEMBER 2019. 15. The extent and nature of circulation: A. Total number of copies printed (Net press run). Average number of copies each issue during preceding 12 months: 30,080. Actual number of copies of single issue published nearest to filing date: 30,071. B. Paid/requested circulation. 1. Mailed outside-county paid subscriptions/requested. Average number of copies each issue during the preceding 12 months: 13,884. Actual number of copies of single issue published nearest to filing date: 15,783. 2. Mailed in-county paid subscriptions/requested. Average number of copies each issue during the preceding 12 months: 0. Actual number of copies of single issue published nearest to filing date: 0. 3. Sales through dealers and carriers, street vendors and counter sales. Average number of copies each issue during the preceding 12 months: 0. Actual number of copies of single issue published nearest to filing date: 0. 4. Requested copies distribution through other classes mailed through the USPS. Average number of copies each issue during the preceding 12 months: 150 Actual number of copies of single issue published nearest to filing date: 153. C. Total paid/requested distribution. Average number of copies each issue during preceding 12 months: 14,034. Actual number of copies of single issue published nearest to filing date: 15,936. D. Non-requested distribution (by mail and outside mail). 1. Outside-County Non-requested copies. Average number of copies each issue during the preceding 12 months: 15,649. Number of copies of single issue published nearest to filing date: 13,850. 2. In-county non-requested copies. Average number of copies each issue during the preceding 12 months: 0. Number of copies of single issue published nearest to filing date: 0. 3. Non-requested copies mailed at other Classes through the USPS. Average number of copies each issue during preceding 12 months 0. Number of copies of single issue published nearest to filing date: 0. 4. Non-requested copies distributed outside the mail. Average number of copies each issue during preceding 12 months: 119. Number of copies of single issue published nearest to filing date: 250. E. Total Non-requested distribution. Average number of copies each issue during preceding 12 months: 15,768. Actual number of copies of single issue published nearest to filing date: 14,100. F. Total distribution (sum of 15c and 15e). Average number of copies each issue during preceding 12 months: 29,802. Actual number of copies of single issue published nearest to filing date: 30,036. G. Copies not Distributed. Average number of copies each issue during preceding 12 months: 278. Actual number of copies of single issue published nearest to filing date: 35. H. Total (sum of 15f and 15g). Average number of copies each issue during preceding 12 months: 30,080. Actual number of copies of single issue published nearest to filing: 30,071. I. Percent paid. Average percent of copies paid/requested for the preceding 12 months: 47.1%. Actual percent of copies paid/requested for the preceding 12 months: 53.1%. 16. Electronic Copy Circulation: A. Paid Electronic Copies. Average number of copies each issue during preceding 12 months: 0. Actual number of copies of single issue published nearest to filing date: 0. B. Total Paid Print Copies (Line 15c) + Paid Electronic Copies (Line 16a). Average number of copies each issue during preceding 12 months: 0. Actual number of copies of single issue published nearest to filing date: 0. C. Total Print Distribution (Line 15f) + Paid Electronic Copies (Line 16a). Average number of copies each issue during preceding 12 months: 0. Actual number of copies of single issue published nearest to filing date: 0. D. Percent Paid (Both Print & Electronic Copies) (16b divided by 16c x 100). Average number of copies each issue during preceding 12 months: 0.0%. Actual number of copies of single issue published nearest to filing date: 0.0%. I certify that 50% of all distributed copies (electronic and print) are paid above nominal price: N/A. 17. Publication of statement of ownership for a Requester publication will be printed in the October 2019 issue of the publication. 18. Signature and title of editor, publisher, business manager, or owner: Gary Reichert, Publisher. I certify that all information furnished on this form is true and complete. I understand that anyone who furnishes false or misleading information on this form or who omits material or information requested on the form may be subject to criminal sanction and civil actions.

ing self storage, residential, agricultural and commercial. Trac-Rite is dedicated to providing customized, worry-free, low-maintenance products delivered with uncompromising service.



Trachte Building Systems

314 Wilburn Rd.
Sun Prairie, WI 53590
800-356-5824
608-837-0251 (fax)
tbs@trachte.com
www.trachte.com

Trachte Building Systems designs, manufactures, and erects a full line of durable, pre-engineered and customized steel self-storage systems, including single and multi-story, portable storage, interior partition and corridor, refurbishments, and boat/RV. Trachte is committed to helping owners make informed decisions with our knowledgeable sales team who offers advice every step of the way. This commitment, along with over 119 years of manufacturing experience, has given the company a leading edge in the self-storage industry.



Triangle Fastener Corporation

1925 Preble Ave.
Pittsburgh, PA 15233
412-321-5000
412-321-7838 (fax)
sales@trianglefastener.com



Triangle Fastener Corporation (TFC) is a leading supplier of standard and specialty fasteners, tools, sealants and accessories for the commercial construction industry. A complete line of fasteners for metal-to-metal, metal-to-wood, drywall and concrete anchoring is available from each of its 23 locations. TFC has eight in-house painting facilities that custom color-match fasteners to exact requirements with delivery in three days or less. TFC offers job-site and technical assistance, inventory management programs and product development. Our NEW PANEL-TITE® with the patent pending BURR-BUSTER® point is engineered to reduce burrs and provide more resistance to back-out! TFC market-specific catalogs can be found on the company's website and are complete with products and technical information on a wide variety of fastening systems solutions. Visit our website to learn more.

Van Mark Products

24145 Industrial Park Dr.
Farmington Hills, MI 48335
800-826-6275
888-826-6275 (fax)
sales@van-mark.com
www.van-mark.com

Varco Pruden Buildings

3200 Players Club Cir.
Memphis, TN 38125
901-748-8000
901-748-9323 (fax)
sales@vp.com
www.vp.com



Ventco

115 Lismore Ave.
Glenside, PA 19038
800-300-9515
215-887-7975 (fax)
mrotter@ventcoinc.com
www.shear-x.com



Viking Equipment Finance

5900 S Lake Forest Dr. Ste. 300
McKinney, TX 75070
972-885-8899
info@vikingequipmentfinance.com
www.vikingequipmentfinance.com/construction



Walters Buildings

Walters Buildings

PO Box 388
Allenton, WI 53002
800-558-7800
sales@waltersbuildings.com
www.waltersbuildings.com



Wick Buildings

Wick Buildings

405 Walter Rd.
Mazomanie, WI 53560
608-795-2294
608-795-2534 (fax)
buildings@wickbuildings.com
wickbuildings.com



Wick Buildings is a leader in the post-frame industry. Founded in 1954, with more than 75,000 buildings completed,

Wick builds everything from industrial and light manufacturing facilities to bank and aviation buildings, as well as gas stations, churches, equine and livestock facilities.

Wrisco Industries, Inc.

355 Hiatt Dr., Suite B
Palm Beach Gardens, FL 33418
800-627-2646
561-627-3574 (fax)
sales.staff@wrisco.com
www.wrisco.com

**TO HAVE YOUR COMPANY
ADDED TO THE
RURAL BUILDER
ONLINE COMPANY
DIRECTORY**

CONTACT

**Kathy (kathy@shieldwallmedia.com) or
Karen (karen@shieldwallmedia.com)**

Contractors...
now you can perforate your **AG Panels AND FLAT STOCK** with the **AG PANEL PERFORATOR!**

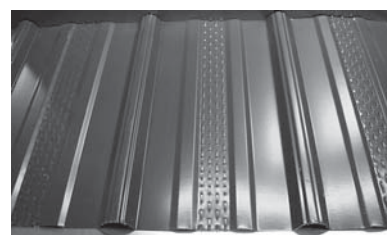
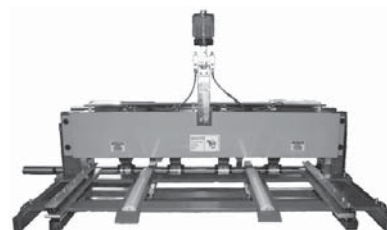

- HD Electric - Gearbox Drive
- Four (4) Sets of Perf Dies
- 29 - 26 ga. Steel for AG Panels
- 29 - 24 ga. Steel, .032" Aluminum - Flat Stock

ROLL FORMER CORPORATION

Call us today at 215-997-2511
www.rollformercorp.com

Circle Reader Service #442

PRODUCT PROFILES

SUPPLIES AND SOLUTIONS FOR THE RURAL BUILDER



Photo courtesy of Midland Door Solutions

THE FOLLOWING PAGES OF THIS YEAR'S RURAL BUILDER BUYERS' GUIDE FEATURES PRODUCTS THAT RURAL BUILDERS NEED FOR MAKING GOOD BUILDINGS GREAT. Each listing includes product information and a snapshot of the product, plus a website address, phone number or email address where you can find additional information.

Categories are listed alphabetically in the table of contents below.

Whether you're looking for a better way to hold things together, light up an interior with natural light, add aesthetics with a custom-painted door and hardware, or keep moisture out and heat in, you'll find a solution here.

TABLE OF CONTENTS

- | | | | |
|-----------|---|-----------|---|
| 35 | Adhesives, Sealants and Caulks | 50 | Insulation/Moisture & Vapor Barriers |
| 36 | Building Packages | 51 | Other: In-Floor Heating; Metal Shingles |
| 38 | Coils and Coatings | 52 | Roof & Wall Panels |
| 40 | Doors and Door Hardware | 54 | Roofing Components
(snow and rain management) |
| 42 | Farm and Ranch Building Supplies | 56 | Tools and Equipment |
| 44 | Fasteners
(nails, screws, clips, clamps and connectors) | 60 | Ventilation |
| 48 | Foundation and Truss Products
(engineered trusses, columns and column protection) | 62 | Windows, Skylights and Daylighting |

Adhesives, Sealants, & Caulks

SUPPLIES AND SOLUTIONS **Rural Builder**

Albion Engineering Co.



Quickly seal exposed fasteners on metal roofs with the Spot-Pro Extension Nozzle (1032-G02). Applies a consistent dab of sealant to each screw head without bending over. The Spot-Pro nozzle has integrated spring-loaded check-valve, will not drip or dispense sealant until it is activated by pressing against screw head. For greatest versatility use with Albion combo gun B12B30HJ (dispenses 30oz Bulk, 20oz Sausage, or 10oz Cartridge).

www.albioneng.com

Triangle Fastener Corporation



APS500 Advanced Polymer Sealant is engineered to produce superior adhesion to metal, coated metals, wood, masonry, PVC and most common construction materials. It is a class 50 sealant that provides exceptional movement capabilities compared to other class 25 sealants. It is UV resistant, paintable and provides long-life performance. It is formulated to install in temperatures as low as -32 degrees Fahrenheit and can be made in more than 100 colors.

www.trianglefastener.com

GSSI Sealants, Inc.



GSSI manufactures premier elastometric butyl rubber sealant tapes. We have been producing tapes for a wide range of industries and applications for more than 30 years. Our MB-10A is a premier elastometric butyl rubber sealant designed to meet the critical requirements of metal building applications.

www.gssisealants.com

Marco Industries



Marco's Weather-Tite™ Metal Roof Sealant stands up to the elements better than all other sealant technologies. Our eco-friendly polymer sealant offers a waterproof seal against water, wind, dust, dirt, and other infiltrations. It adheres to almost any common building materials and comes in more than 30 standard colors. Marco's Weather-Tite™ Metal Roof Sealant is tack-free in one hour, is paintable (excluding translucent), and is ideal for use on a wide variety of products.

www.marcoindustries.com

*Since 1954.
Trusted.
Tested.
True.*



CHIEF[®]
BUILDINGS

www.chiefbuildings.com

Circle Reader Service #403

Building Packages

SUPPLIES AND SOLUTIONS

Sukup Steel Buildings



Sukup Manufacturing Co.'s pre-engineered steel buildings feature clear span construction and standing seam or screw-down roofs. The clear span design allows for flexibility in customizing interior space to meet customer needs. Purlins and girts are galvanized for long life and pre-punched to ensure proper fit and faster installation. A variety of sidewall and trim colors and options are available.

www.sukup.com

CHIEF Buildings



CHIEF Buildings is one of the largest family-owned metal building manufacturers in the United States, operating since 1954. It prides itself on producing quality products and providing unparalleled personal attention to meeting the needs of its customers. For farm or commercial use, CHIEF Buildings promises to deliver: "Trusted. Tested. True."

www.chiefbuildings.com

Trachte Building Systems



Trachte Building Systems designs, manufactures, and erects a full line of durable, pre-engineered and customized steel self-storage systems, including single and multi-story, portable storage, interior partition and corridor, and boat/RV. Trachte is committed to helping owners make informed decisions with a knowledgeable sales team that offers advice every step of the way. This commitment, along with more than 115 years of manufacturing experience, has given the company a leading edge in the self-storage industry.

www.trachte.com

Walters Buildings



Better Business Bureau, maintaining an A+ rating. The company manufactures many of the components in their buildings to insure consistency of quality. When other suppliers are used, it is with American-made products. Walters has its own in-house licensed engineering team to make sure your building is designed to meet all codes. It provides drawings, renderings, and elevations so you can visualize your building during the design process.

www.waltersbuildings.com

FBI Buildings



Building post frame confidence in the Midwest for agricultural, commercial, equine, and suburban buildings for over 60 years.

www.fbibuildings.com

Energy Panel Structures



With headquarters in Graettinger, Iowa, EPS manufactures pre-engineered post-frame and SIP buildings from three plants across the U.S. EPS markets these buildings through a dedicated dealer/builder network. Builders can offer customers building packages for residential, agricultural, and commercial use. Since 1981, EPS has helped dealers to grow and find success by providing a complete engineered building package, technical training, sales and marketing support, along with the most diversified product line in the industry.

www.epsbuildings.com

Central States Manufacturing



Central Storage Works, a division of Central States Manufacturing, brings you a new level of quality, service, and convenience that beats the competition. Quick quote-to-complete self-storage packages come with everything you'll need to erect mini storage, boat, RV or climate-controlled storage. Central Storage handles everything including the design, manufacturing and delivery of these complete self-storage building packages. Quality products are delivered on time at a great value.

www.centralstatesmfg.com

Graber Post Buildings



Graber Post Buildings continues to be a phone call away for all post-frame building materials and do-it-yourself packages. GPB manufactures metal panels for any residential, commercial, industrial, agricultural or roofing application. It also produces custom trusses, metal trims, laminated poles and also features a steel coil division.

www.graberpost.com

Wick Buildings



Wick Buildings is a leader in the post-frame industry. Founded in 1954, with more than 75,000 buildings completed, Wick builds everything from equine and livestock facilities to industrial and light manufacturing facilities to bank and aviation buildings, as well as gas stations, churches, and residences.

www.wickbuildings.com

Is Your Catalog Available Online? Is Your Catalog In Our Library?

Rural Builder, Metal Roofing Magazine, Frame Building News, and Rollforming Magazine are combining resources to create a CATALOG LIBRARY for our readers.

**Rural
Builder**

**METAL
ROOFING**

**FRAME
BUILDING
NEWS**

**Rollforming
Magazine**



Rural Builder, Metal Roofing Magazine, Frame Building News, Rollforming Magazine, Roofer Express and Builder Express subscribers can find advertisers' catalogs and products literature in one place, online 365 days per year.

Contact us today for more details

Gary Reichert • 715-252-6360 • gary@shieldwallmedia.com

Coil & Coil Coatings

SUPPLIES AND SOLUTIONS

Rural Builder

AkzoNobel



AkzoNobel is a leading global paints and coatings company. We supply industries and consumers worldwide with innovative products and are passionate about developing sustainable answers for our customers. Our coil coatings provide beautiful topcoats, durable surfaces, innovative applications, green benefits, and cost savings as to other substrates and coating options.

www.akzonobel.com/ccna

Dura Coat Products



Dura Coat Products offers two high-performance coil coatings. Durapon 70 is a PVDF formulation with exceptional durability and fade resistance that is also available with thick film primer for tougher environments. Ceranamel XT40 SMP is a polymer that is harder, yet more flexible than ordinary coatings. Both are Energy Star compliant.

www.duracoatproducts.com

Prassas Metal Products Inc.



PMP Steel is a 29-year-old steel trading and coated coil distributor, specializing in pre-painted galvalume coil intended for a variety of industry applications; including residential roofing, metal buildings, roll-up and garage doors. PMP Steel maintains coil distribution centers at Savannah, GA and Tampa, FL. PMP Steel stocks ValsparXL, Akzo1050, Generic SMP-Cool PPGL, 29 ga x Regular Polyester PPGL, and Acrylic Galvalume (29 ga - 22 ga) in a wide range of widths.

www.pmpsteel.com

Steel Dynamics Inc.



Steel Dynamics delivers the ultimate in long-lasting, great-looking protection with acrylic and pre-painted Galvalume in any color you can imagine. That means no added processing steps, no additional shipping costs and no added hassles. In fact, Steel Dynamics has a full line of quality steel products for the post-frame construction market, including the widest flat roll sheets in North America, up to 72-plus inches. We currently have facilities with Galvalume capabilities in Indiana and Mississippi, with plans underway to expand in Sinton, Texas, so we've got you covered geographically, too.

www.steeldynamics.com

Sherwin-Williams Coil Coatings

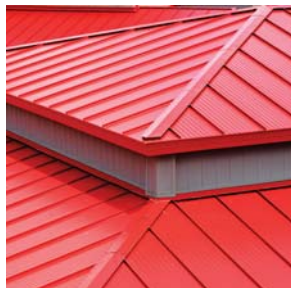

Sherwin-Williams Coil Coatings, formerly Valspar, offers a full range of high-performance architectural metal coatings in PVDF, SMP, and polyester formulas. Fluoron is its flagship coating, containing 70 percent PVDF resins, and offering premium protection against harmful UV rays, chalk, fade and chemical degradation. WeatherXL, the next generation enhanced silicone polyester coating, offers protection against weathering for years to come. WeatherXL Crinkle Finish coating offers a unique textured appearance. Each is extremely durable and have excellent film integrity and adhesion properties.

www.coil.sherwin.com

EPDM Coatings



Fix roof leaks once, with the only liquid EPDM Rubber in the world. Over a 25-year history of success. This catalyst-based one-coat system has a unique curing process allowing for cross-linking to occur, creating a chemical bond to the substrate it is applied on. It waterproofs immediately and can withstand ponding water 365 days a year. Liquid EPDM Rubber will take temperatures from -60 to 300 degrees. It is UV and Ozone resistant and has proven itself superior to acrylics, urethanes, and other elastomers for up to four times longer. To get your sales packet and volume pricing, visit the website.

www.epdmcoatings.com

STAY INFORMED

GET YOUR FREE SUBSCRIPTION TODAY!

Roll-formed metal wall and roof panels comprise a large portion of the agricultural, commercial, post-frame and residential construction markets. *Rollforming Magazine* is dedicated exclusively to this section of the construction trade.

This specialty publication is a platform to share and discuss developments in roll-forming technology, operations, and opportunities.

Each issue delivers news and information created expressly for the roll-forming industry. *Rollforming Magazine* focuses on the products and services that professionals find indispensable, including:

- Roll formers: Stationary and portable;
- Panels, gutter, and trim;
- Seamers, decoilers, benders and brakes;
- Coil, coatings, accessories, consumables; and
- Controls, software, after-market accessories, & more.

If you sell to or provide services to this segment of the construction trade, you need to subscribe to *Rollforming Magazine*; it is a resource you can use to help build your business.



To subscribe, visit <https://www.constructionmagnet.com/subscribe>

Rollforming
Magazine



Doors & Door Hardware

SUPPLIES AND SOLUTIONS

A.J. Manufacturing



A.J. Manufacturing builds high quality steel walk doors. Options include pre-painted white, clay, bronze or brown panel and frame, or fully stainless steel doors. A.J. doors are pre-hung in steel, aluminum or stainless steel frames with 4 x 4.5-inch fixed pin, or ball bearing hinges for 4-way universal swing, even with a foamed-in-place door lite or a deadbolt bore. The 1-3/4-inch doors are polyurethane foam injected for an R-12 insulating value.

www.ajdoor.com

Midland Door Solutions



Midland Door Solutions is the unparalleled leader in the design, manufacturing and installation of custom bi-fold and hydraulic doors. Our doors can be designed to accommodate any facade to compliment your building aesthetics. Since 1995 Midland has been providing solutions to customers' big door needs. We guarantee the best customer service and lowest total cost of ownership within the industry.

www.midlanddoorsolutions.com

Schweiss Doors



For 38 years, Schweiss Doors has been a leading manufacturer of hydraulic one-piece doors, patented Lift Strap / Autolatch Bifold Doors and a new dynamic line of designer doors. Renowned for quality craftsmanship, these custom-made engineered doors are specially designed for many applications, without loss of headroom, including: commercial, industrial, agricultural, residential, aircraft hangars and designer doors.

www.schweissdoors.com

Trac-Rite Door



Trac-Rite Door manufactures quality steel roll-up doors for a multitude of uses including self storage, residential, agricultural, and commercial. Trac-Rite is dedicated to providing customized, worry-free, low-maintenance products delivered with uncompromising service.

www.tracrite.com

PowerLift Hydraulic Doors



PowerLift has built hydraulic doors continuously since 1992. It has 37 local support centers that manufacture, deliver and install every single door. PowerLift strives to make your building project and your long-term ownership experience simple and hassle free.

www.powerliftdoors.com

Safe-Way Door



Safe-Way Door is a leading manufacturer of quality residential, commercial and industrial overhead garage doors in steel, wood and aluminum. Headquartered in Warsaw, Indiana, Safe-Way Door also operates facilities in Tennessee and Missouri with distribution throughout North America and Canada. Doors are available in multiple configurations including polyurethane and polystyrene insulated, uninsulated and up to 10 colors in steel and multiple powder-coat colors in aluminum. Commercial door sizes are available in all of the panel designs. Pictured is the Regency Model 70 in the new Driftwood Grey.

www.safewaydoor.com

Silvercraft



Silvercraft is the home of pre-assembled aluminum Dutch and sliding doors. These premium doors are available for any equine facility or hobby building. Silvercraft also manufactures bifold doors, walk doors, and other products for the poultry and agricultural building industries.

574-825-8757

CannonBall:HNP



Since 1916, CannonBall has offered a complete, best-warranted line of round track products and accessories, including industry-standard keyhole track, for the post-frame and metal building industries. A wide variety of entry doors, like the cost-effective 1700-Series in steel and aluminum jambs (pictured), are manufactured with versatile design and affordable pricing for agricultural, commercial, and metal building projects. Builders also rely on CannonBall for Dutch doors, sheeting and wall cladding products, cupolas, horse stalls, windows, builders' hardware and more.

www.cnbhnp.com

Plyco



If you're looking for a commercial, residential or agricultural door, Plyco has the right door for your construction projects. Contractors rely on Plyco for a comprehensive line of durable walk doors that meet today's building codes. Plyco offers pre-hung service doors individually packaged, pre-drilled for lock set, and insulated with injected polyurethane foam. Plyco walk doors are perfect for post frame, metal frame and commercial buildings.

www.plyco.com

Extrutech Plastics



Extrutech All Weather Doors are corrosion proof, bright white, with a smooth flat 1-3/4-inch thick PVC door panel and solid PVC frame with a weather strip sealed edge. They are available as single and double doors, in standard or custom sizes, as well as replacement door panels to fit existing frames. For use in high moisture, salty, acidic areas where corrosion may be a problem, or for controlled environments such as car washes, dairies, laboratories and more.

www.epiplastics.com

Erect-A-Tube Inc.



Erect-A-Tube Inc. designs, engineers and manufactures electric bifold doors, bottom rolling doors, aircraft T-hangars and clear-span hangars for the general aviation and business jet markets. Utilizing the structural qualities of HSS tubing, a bridge-truss design was developed, providing minimal deflection, smooth operation of the door system and flexibility in hangar design. With 56 years of manufacturing experience, Erect-A-Tube's single-source product line, with a fully-integrated system, results in ease of construction and years of reliable service.

www.erect-a-tube.com

MWI Components



Doors are the loudest statement you will make with your building. What are you trying to say? MWI Components will make the impression you strive for. Choose from thousands of color combinations for your Dutch, bale, French or sliding doors. MWI's completely galvanneal substrate doors come in double cross-buck or half-light options; the company also offers Arcadian Sliding Doors in fully assembled or kit form. Those looking to finish the job to perfection can look to the Arcadian Sabre Slim. This exterior, lockable, polished, chrome plated handle with keyed entry on 1-1/2-inch Split Sliding Arcadian Doors and interior latch functions will make your doors the talk of the industry.

www.mwicomponents.com

Farm & Ranch Building Supplies

SUPPLIES AND SOLUTIONS

Sukup Steel Buildings



Not only are Sukup Steel Buildings perfect for a shop or machine shed, but now they also make “hopper buildings” to make grain loading more efficient. The new hopper buildings bring together several state-of-the-art grain handling and storage technologies of Sukup Manufacturing and its Sukup Steel Buildings division.

www.sukup.com

CannonBall:HNP



CannonBall offers horse stall systems in black powder-coated 14-gauge galvaneal steel and anodized extruded aluminum materials. Stall grille sections, window grilles and door packages are available in a variety of section lengths, and formed to fit standardized dimensional lumber for easy installation. Track and trolley systems, feeders and a full assortment of finishing accessories also complement traditional post and free-standing construction projects.

www.cnbhnp.com

Graber Post Buildings



Graber Post Buildings has been building horse barns and supplying products and materials for horse barns since 1973. It has every item you'll need, from the complete building package to the smallest stall component including Dutch doors, sliding doors and other horse stall components. Also shop Graber Post for all sizes of tongue and groove lumber to construct your stalls.

www.graberpost.com

Plyco



Plyco offers a complete line of components for horse barns and livestock facilities. Plyco is a leading supplier of wholesale horse stall kits, horse stall grilles and gates and horse stable Dutch door systems, all available in a variety of custom styles. The company has its own hardware for slide doors: Ply-Trac and Combo. Horse barns can be topped off with ridge vents and cupolas from Plyco. Durable doors for livestock buildings include the 98 Series line of walk doors, all constructed to survive the most corrosive environments.

www.plyco.com

Rollformer Corporation



Roll Former Corporation now offers two (2) perf units: the Stand Alone Perf Unit with 2 sets of perf dies for up to 24-inch wide flat stock, and the Ag Panel Perforator for ventilation needed on your ¾-inches by 5 rib wide ag panels. Complete with 4 sets of perf dies for this 38-inch wide popular panel. It can also perforate “flat stock” so you can post process the rest of your ventilated trim products. 26 – 29 gauge ag panels or 24 gauge max flat stock. Call us today at 215-997-2511 or visit us online.

www.rollformercorp.com

MWI Components



MWI is a leading manufacturer of equine building components, producing stall fronts, partitions and components, Dutch or bale doors and sliding doors. MWI currently offers more than 35 colors of powder-coat paint with a full-service in-house paint line. MWI also powder coats three profiles of slide door rails, painted quickly to finish a building so customers no longer need to settle for white doors or black stalls. Put your own personal touch on your equine facility using parts from MWI Components.

www.mwicomponents.com

Rural Builder

Wick Buildings



Wick Buildings is a leader in the post-frame industry. Founded in 1954, with more than 75,000 buildings completed, Wick builds everything from equine and livestock facilities to industrial and light manufacturing facilities to bank and aviation buildings, as well as gas stations, churches, and residences.

www.wickbuildings.com

EMAIL YOUR INFORMATION TO OUR READERS

- **REACH:** Rural Builder, Frame Building News, Metal Roofing, Rollforming Magazine Readers
- **TIMING:** Send when you want to coordinate with product releases, special events or trade shows
- **RESPONSE:** Prospects can click on the ad and respond to you immediately
- **ACCOUNTABILITY:** You get a report showing how many readers received, opened and clicked on your DEBs

CONTACT:

Gary Reichert
gary@shieldwallmedia.com – 715-252-6360



MENTION THIS AD & YOUR SECOND DEB IS HALF PRICE

IT'S FREE, SIGN UP TODAY!

Sign up to receive these great products, just go to **ConstructionMagNet.com**.

GET THE LATEST NEWS, TIPS AND TRENDS DELIVERED RIGHT TO YOUR INBOX.

Builders' Express
Bi-Weekly E-Newsletter

Roofer Express
Bi-Weekly E-Newsletter

FRAME BUILDING NEWS

Rural Builder

METAL ROOFING MAGAZINE

Rollforming

ConstructionMagNet.com

Fasteners: Nails & Screws

SUPPLIES AND SOLUTIONS

BECK America®



The RoofLoc® SCRAIL® system was developed to install metal roofing and facades quickly and efficiently. Two times faster than collated screws, and eight times faster than bulk screws, this performance could only be achieved through the combination of the pneumatic Roofing Installation Tool and the patented RoofLoc® SCRAIL®. The tool design allows for excellent ergonomics and tool balance, which promotes better ease of use, even on the longest, toughest jobs.

www.beck-fastener.com

Maze Nails



Maze is the exclusive manufacturer of Stormguard double hot-dipped galvanized nails with a lifetime warranty against rust. In business since 1848, Maze offers a full line of specialty nails in bulk for hand driving and in collated sticks and coils for popular pneumatic nailers. Maze has been serving the post-frame industry for many years, providing painted rubber washer nails for corrugated roofing and siding. Maze post-frame nails meet the all-important ASTM F 1667 specification. In addition, Maze manufactures nails for fiber cement siding products, cedar and redwood sidings, fencing, decking and roofing. Maze nails are proudly made in the USA in Peru, Illinois.

www.mazenails.com

Triangle Fastener Corporation



Panel-Tite metal-to-wood screws includes TFC's patent-pending Burr-Buster thread that reduces burrs and provides better resistance to back-out. Choose from #9, #10, #12, and #14 diameter screws in carbon steel or stainless steel. For more than 40 years, Triangle Fastener Corporation has specialized in supplying hard-to-find fasteners, sealants, tools and accessories for construction. TFC offers job-site support, and can help you select the correct fastener for your application from any of 23 locations.

www.trianglefastener.com

East Coast Fasteners



East Coast Fasteners produces durable fasteners for all combinations of building materials. The Ply-Lo Extreme line of fasteners is designed for extreme environments. The Ply-Lo Driller is the latest innovative addition to the company's fastener line, designed to save contractors time and money. The Ply-Lo Driller features a patent pending design intended to be more forgiving than other fasteners. This means the tip is designed to reduce the likelihood of "walking" when fasteners are driven at a slight angle. Less walking means quicker and easier installation as well as a reduction in material damage and waste. The Ply-Lo Driller is available in colors to match virtually any panel as a #10 fastener in lengths of 1, 1-1/2, 2, 2-1/2 and 3 inches.

www.plyco.com

Dynamic Fastener



Dynamic Fasteners offers a variety of specialized fasteners, including the D.F. brand self-drilling screws made for stitching and sheet-to-structural applications; pole barn fasteners for attaching up to 18 gauge sheet metal to wood; and clip screws that require a low-clearance head when fastening to steel or wood. Fasteners are available in stainless steel and with the Dyna-Coat 1,000 hour salt spray premium coating.

www.dynamicfastener.com

Leland Industries



Leland boasts the fastener industry's first "long-life" powder coating warranty to match WeatherX, Perspectra-cote and matte finish paint systems. Leland has a complete line of fasteners for residential roofing, wood-frame or steel-frame projects. Self-drilling and self-tapping screws available in #10, #12 and #14 diameters, in lengths to eight inches. Fasteners manufactured in carbon or stainless steel, and powder coated to match panel colors. Leland's powder coating covers the head and under it where corrosion begins.

www.lelandindustries.com

DB Building Fasteners



DB Building Fasteners carries a complete line of sheet-to-wood fasteners in #9 and #14 diameter up to 3 inches long and coated in DB's long-life Mag coating. DB also carries a complete line of self-drilling fasteners along with in-house closure stamping and fastener painting. DB can custom color match any color including metallics and chameleon colors.

www.selfdrillers.com

ST Fastening Systems



ST Fastening Systems manufactures and supplies steel-frame and post-frame screws. Drill quality and corrosion resistance are showcased on the Maxx SteelBinder and WoodBinder MB with micro-bit technology. This point eliminates the slow-drill or no-drill complaint about sharp-point screws. All standard metal-to-wood screws have transitioned to this point, including the increasingly popular ZXL WoodBinder zinc-aluminum alloy head for 40-year-warranty roof systems. Solid and vented foam closures, pipe flashings, pancake- and wafer-head screws for standing seam roofs round out the product line.

www.stfasteningsystems.com

Did You Know?

By Tom Hulsey

- Screws date back to 3rd Century BC in Greece. By the 1st Century BC, screws were commonly used throughout the Mediterranean area in screw presses in the processing of olive oil and grapes.
- The spiral thread has proven over time to be an effective means to provide the force needed in order to perform specific tasks. Screws were originally made by hand for use in the assembly of materials to form a secure attachment of one piece to another. Originally, there were no standards to guide the making of the screw.
- Around 1800, with the development of a modern screw cutting lathe, screws could be made more precisely and therefore could be produced much faster than before. Consequently, the development and standardization of thread forms became important for reproducibility and interchangeability in use.
- In the late 1860s and early 1870s, the US Standard Thread was created. Thread designs and thread forms continued to evolve. Sometime around 1916, the SAE Standard (Society of Automotive Engineers) was established in order to augment the US Standard. This standard defined thread forms and specifications for threaded fasteners for general use. These standards were later adopted by ANSI (American National Standards Institute). IFI (Industrial Fasteners Institute) is also a standards publisher that defines thread forms for fasteners.
- Nails, as a means of fastening wooden objects, date back to approximately 3400 BC in ancient Egypt. The term "penny" probably originated in medieval England to describe the price of 100 nails. The "d" that is used as abbreviation for penny is derived from Latin for the name of the Roman coin, Denarius.
- Until the early 1800s, nails were made by hand. Around 1800, cut nails (square nails) were made from wrought iron. Around the 1860s, wire nails were introduced, and by the early 1900s, 90 percent of all nails were wire nails. **RB**

SFS



SFS ConnexTite structural wood screw line is ideal for single and multi-ply truss, column header and joist applications, providing quicker installation and lower installed costs versus carriage bolts or ring shanked nails. Featuring a large flange head and aggressive thread design ensures quick, tight connections. The ribbed point cuts through the densest lumber without splitting. ConnexTite fasteners install with an impact gun and T25 or T40 bit and carry IBC 1603 approval for structural connections.

www.sfsintecusa.com

Levi's Building Components



The Fastgrip #10 MINI-DRILLER has all of the specs that make the Fastgrip #10 Hi-Lo the go-to fastener, but with the added MINI-DRILLER point. The MINI-DRILLER makes easy work of driving through metal panels, while the Hi-Lo thread provides superior pull-out strength in metal to wood applications.

www.levisbuildingcomponents.com

Fasteners: Clips, Clamps, Connectors

SUPPLIES AND SOLUTIONS

Rural Builder

ESE Machines, Inc.



ESE Machines, Inc. sells Stainless Steel and Galvanized cleats for 1" or 1.5" double lock standing seam panels. Cleats come in a Fixed single-piece style or an Expansion two-piece sliding style. UL580 testing is available on most cleats. ESE also sells hand tools, power seamers and Decoilers.

www.esemachines.com

MWI Components

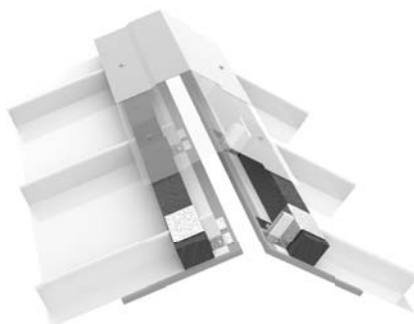

MWI Components' Universal Ridge Clip is a 22-gauge, galvanized clip that provides a large fastening area for any style ridge cap on a standing seam roof. With this clip, no fasteners penetrate the panel where they will be exposed to the weather, and no fasteners need to penetrate the standing seam.

www.mwicomponents.com



RFOIL INTRODUCES RETROFIT MBI SYSTEM

The new Retrofit MBI System is a unique and innovative take on insulating existing metal buildings. The patented clip and pin system combined with rFOIL's reliable insulation provides a cost-effective and energy-efficient way to insulate all types of metal buildings. The MBI Retrofit clip is installed to the bottom of the exposed roof purlins and inside the wall girts. The system allows for the addition of insulation mass. The Retrofit MBI System is lightweight, easy to handle and install. With its unique attachment system, it can be quickly installed with minimal interruption to the facility's operation.

www.rfoil.com

Direct Metals Inc.



Direct Metals Inc. (DMI) is a fastener manufacturer and master distributor of a wide range of building fasteners engineered for the metal roofing and post-frame building markets. DMI has a full line of post-frame fasteners, panel clips, clip fasteners, pipe flashings, ventilation and a full line of metal roofing accessories.

www.directmetalsinc.com

AceClamp



AceClamp is a manufacturer of precision-engineered snow retention and solar mounting systems, like fast-installing Rackless Solar Mounting Kits. Today, AceClamp is setting the bar in solar racking with its most recent innovative product called "Solar Snap." "Solar Snap" is an Adaptive Solar Racking System that works on every roof and uses AceClamp's fully-assembled, non-penetrating clamps. Slide in pre-assembled components along the rail and secure. Simplify your inventory with one clamping system for all rooftop needs. (Shown with SSMR.)

www.aceclamp.com



Step 1



Step 2



Step 3

GET YOUR PRODUCT FEATURED

AN EXCLUSIVE OFFER ONLY TO OUR ADVERTISERS!

YOUR PRODUCT, INCLUDING A PHOTO AND DESCRIPTION, WILL BE VIEWED BY AN AUDIENCE OF INDUSTRY PROFESSIONALS IN PRINT, EMAIL BROADCASTS AND ON OUR WEBSITE.

THERE ARE THREE WAYS TO GET YOUR PRODUCT PROFILE INCLUDED:

- 1** You have purchased an ad (any size) in the same issue that your Product Profile will appear.
- 2** You buy the Product Profile placement and this purchase includes a spot in a group Product Profiles email.
- 3** Your product is new and newsworthy and our readers will find it of value. If your company meets one of the qualifications listed, you must submit the following information:
 - 50-75 word description of your product or product line
 - High resolution (300 dpi) photo of your product. (Sorry: We do not use logos or ads for the Product Profiles.)



For more information
contact: Gary Reichert at
gary@shieldwallmedia.com
715-252-6360

Foundation & Truss Products

SUPPLIES AND SOLUTIONS

Starwood Rafters



Starwood Rafters' laminated wood products include Lam-Ply Truss, the company's most popular product. It combines plywood with glulams and dimensional lumber for stronger trusses that can be spaced farther apart. It can be used in many applications.

www.starwoodrafters.com

Rigidply Rafters



Glue-laminated arches, beams, posts and timber trusses manufactured by Rigidply Rafters Inc. give beauty a completely new meaning. Rigidply also manufactures metal-plated roof and floor trusses, tongue-and-groove and V-groove decking and offers a complete line of post-frame building materials to complete your project.

www.rigidply.com

Perma-Column



Keep your reputation out of the dirt—stop building on temporary foundations. Your customers deserve permanent solutions. Perma-Column precast concrete columns outperform traditional wood posts and easily integrate into your current building process. For poured concrete foundations, Sturdi-Wall and Sturdi-Wall Plus Brackets simplify post-frame construction done right. Perma-Column promises to help you “Build better, build stronger, build to last.”

www.permacolumn.com

Plasti-Sleeve Post Protection



First on the market by many years, Plasti-Sleeve literally created the foundation alternative category for post-frame construction. The clean fitting, easy-to-use, slide-on Post Protection sleeves provide the economical protection that many post-frame customers now expect. Quality black polyethylene plastic, more than 20 specialized sizes, and great pricing make Plasti-Sleeve a smart choice for post protection. Market leadership has continued with Short-Sleeve, for economical grade-level post protection, and Plasti-Skirt, an easy-to-use plastic skirt board protector.

www.plastisleeve.com

Post Protector Inc.



Everyone knows that wood in ‘ground-contact’ is not the optimum environment for maximum longevity performance. The easy-to-install, slide-on Post Protector and snap-on, compression-fit Skirt-Board Protector retain the speed, simplicity, affordability and strength of traditional post frame, while eliminating *all* ground-contact. Builders report that an impressive 60-70 percent of their customers opt for Post Protector products when given the option, while others prudently make the system standard so every customer benefits.

www.postprotector.com

Levi's Building Components



Uplift Plates from Levi's Building Components are designed to help the post-frame builder save time, money and meet or exceed the post uplift requirements for concreted posts. These inexpensive plates can be field applied with just a framing hammer, eliminating the need for extra tools and time associated with rebar and other uplift technology. They're lightweight, easy to handle and easy to install. They are low cost and stronger than rebar and protect the center of the post by eliminating exposure to the elements, thereby resisting decay.

www.levisbuildingcomponents.com

Rural Builder

Graber Post Buildings Inc.



Graber Post Buildings Inc. has been known for more than 30 years as a producer and supplier of quality building products to the post-frame industry. GPB Nail Lam column is another one of its top-quality products. This column has a #1 SPIB certified finger joint and GPB's program is inspected to ensure that its columns meet the high standards that its customers expect. GPB Nail Lam Columns will save you time and money on your next project.

www.graberpost.com

Planet Saver Industries



Green Post from Planet Saver Industries is an affordable, all-in-one solution for in-ground post decay, treatment retention and uplift restraint. Green Post double-layer wrap is factory heat-sealed to the lumber, and delivered ready to install with uplift restraint notches. When used with cement, this technique provides maximum anchorage characteristics, resisting post withdrawal generated by wind load. It is non-toxic, environmentally friendly and termite tested. Richland Laminated Columns LLC, is the newest distributor and manufacturer for Green Post in the Midwest.

Ph: 610-377-3270



Independence, WI



GOTHIC ARCH



MONO



LAM-PLY-TRUSS

RIDING ARENAS • CATTLE ENCLOSURES • STORAGE • SHOPS

- Spans up to 72 ft.
- Bird nesting control
- Up to 12 ft. spacing depending on desired load
- No feed alley post obstruction
- Additional ceiling height for more usable space

starwoodrafters.com • 715-985-3117 • 888-525-5878

GAMBREL



TIMBER TRUSS



Circle Reader Service #375

“All things being equal, the simplest solution tends to be the best one.” – William of Occam

PEEL & SEAL
SELF-STICK ROLL ROOFING



We couldn't agree more.

Peel & Seal® is the best and simplest solution for low-slope roof and flashing repairs. Just peel off the release liner, press into place, and roll smooth to seal the leak. That's all it takes. Leave exposed for years of worry-free protection.

mfm
BUILDING PRODUCTS CORP.

Learn more at www.mfmbp.com
or by calling 800-882-7663.

Circle Reader Service #412

Insulation/Moisture & Vapor Barriers

SUPPLIES AND SOLUTIONS

Kennedy Insulation Group

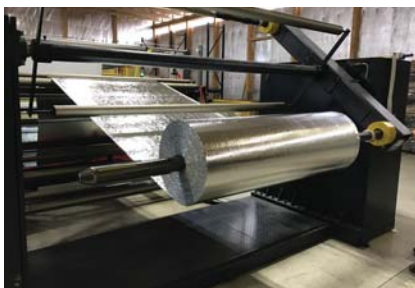

Versola Insulation is manufactured with the highest quality raw materials available. Preventative components to safeguard against deterioration and degradation are added at levels higher than industry standards. Our state-of-the-art bubble lamination machine produces seamless rolls up to 6' in width. Reflective insulation is ALL we do! Made in the USA

www.kennedyinsulationgroup.com

Tape Products Company (TPC)



TPC Tape Products Company is a national distributor for rFOIL reflective insulation. rFOIL is designed to control heat gain or loss and prevent interior condensation in all types of metal and metal-clad buildings, walls, ceilings, crawl spaces, basements, attics, duct work, between joists, under roofing substrates, and under concrete. Reflective insulation reflects 97% radiant heat. Emseal expandable foam tape sealant and RidgeVent polyurethane foam are also available for added insulation and protection.

www.tpcpackagingsolutions.com

Hitz Halter



Hitz Halter by Hershey's the Metal Meister is the superior insulation for all below-grade applications. Developed through intensive research and real-life testing at the company's base in central Illinois, this termite-resistant insulation is manufactured from only the highest quality virgin materials, does not waterlog, does not compress under concrete, and therefore retains its R-value steadfastly even after many years. Hitz Halter is your long-term answer for tremendous energy savings!

HitzHalter@HersheysMM.com

NOFP Inc.



Northwestern Ohio Foam Products manufactures high-performance insulation for the agricultural, residential, commercial and industrial construction markets. MicroFoil, Solex, and Performance Star lines of reflective material are high-quality products offering outstanding features and benefits, including multiple options and R-Values for all your building needs. The Barrier Radiant Floor Under Slab Insulation provides an ideal solution for radiant-heated slab projects.

www.nofp.com

MWI Components

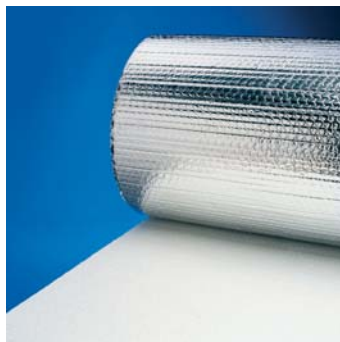

TempShield is a technologically-advanced insulation material ideal for new construction or retrofit installation in residential, commercial, industrial, metal buildings and post-frame buildings. It consists of one or two layers of Barrier Bubble air cellular material laminated between layers of aluminum foil to provide excellent thermal resistance. Offered is a Class A/Class 1 fire rating on white poly/foil insulation. It's available in standard widths of 48 inches and special order widths up to 120 inches.

www.mwicomponents.com

MFM Building Products

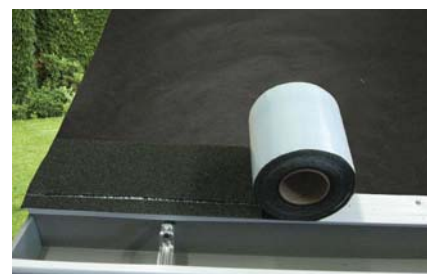

ShingleStarter™ is an easy-to-use, shingle starter course that significantly reduces labor and material costs. This self-adhesive membrane replaces the need to cut shingle tabs and provides an extra level of waterproofing protection that shingle tabs cannot. ShingleStarter features a granulated top surface, sealing strip to bond to the underside of the shingle, and is self-sealing around fasteners to maintain a waterproof barrier. ShingleStarter is suitable for use with traditional 3-tab or architectural shingled roofs. Learn more on the website or by calling 800-882-7663.

www.mfmbp.com

Filc USA LLC

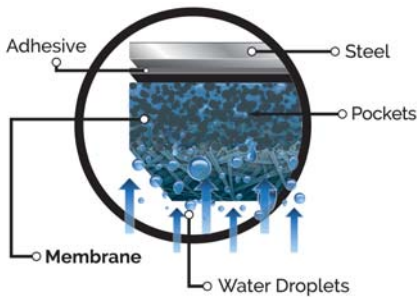

DripStop from Filc USA helps fight condensation without insulation. DripStop traps and holds condensation as it forms until it evaporates back into the air. It arrives at the job site already installed on the steel; saving time and money by eliminating one step of the building process. In addition, DripStop provides a significant layer of protection against corrosion, particularly in animal confinement.

www.dripstop.com

rFoil / Coverttech



rFOIL-2600 series is designed to control heat gain/loss in all types of post frame buildings. It blocks 96 percent of radiant heat transfer, is guaranteed not to delaminate, crack, peel or flake; and carries an unmatched 10 YEAR guarantee on material and labor. rFoil contains UV inhibitors and anti-oxidants for long-term durability, is tested to ASTM G-155 for UV resistance and facing surface degradation, has better thermal value and condensation control than fiber glass insulation, and boasts a class 1/A Fire Rating and passes NFPA-286 full room burn test.

www.rfoil.com

EDCO Products



Weathered Wood Enhanced

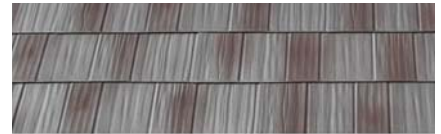

Roadhouse

EDCO Products has introduced two new colors to its award-winning Infinity Textured Shake roofing. Weathered Wood, with enhanced shadow lines, provides a stunning, genuine wood shake appearance. Roadhouse mimics a weathered rustic steel appearance that is highly desirable for residential roofing and sidewall applications. Our proprietary technology gives the appearance of rust without the degradation of actual rust unlike other rustic metal roofing products. Both products have a 40-year fade protection with a lifetime warranty.

www.edcoproducts.com

Plyco Corporation



Ply-Foil is a multi-layer, reflective insulation for use in specialty and standard construction projects. Two outer layers reflect 97 percent of radiant heat. Each layer of foil is bonded to a layer of polyethylene for strength. Inner layers resist conductive heat flow while a center layer of polyethylene gives Ply-Foil additional strength. Perfect for new construction or retrofit.

www.plyco.com

Reflectix, Inc.



The Reflectix® Double Reflective Insulation is the most versatile, widely distributed, energy-efficient product that we manufacture. The characteristics that make it so attractive include ease-of-handling and installation, more than 40+ commercial and residential construction applications, and a large selection of product configurations to accommodate the vast majority of applications/buildings. Distribution of our Double Reflective Insulation is worldwide through do-it-yourself retailers, contractor sales groups and industrial/commercial building products suppliers.

www.reflectixinc.com

Indiana Warm Floors



Scott Patton, owner of IndianaWarmFloors.com radiant heat systems has been in business since 1979. Radiant is the best for comfort and efficiency in residential, commercial and farm projects. Pole barn houses use Combi boilers for heat and hot water. Snow Melt systems are very popular, as well. Pex tubing, placed 9-12 inches off center and the Glycol solution is heated with gas or electric. Systems are installed, or provided as a kit, to builders and contractors in the Midwest and beyond.

www.IndianaWarmFloors.com

Roof & Wall Panels

SUPPLIES AND SOLUTIONS

Replications Unlimited



The URESTONE system is a lightweight, realistic, easy to install faux stone brick and wood panels for adding curb appeal. We offer a wainscot series (typically a 42-inch high panel capped with a built in top ledge), column kits, pilasters and many trim elements. They attach directly to metal building and can be customized for your building design.

www.replicationsunlimited.com

A.B. Martin Roofing Supply



Do you need an extraordinary look for that special project? Get the Aged Metal rustic panels with a 40-year finish warranty. The dual-coat Kynar finish has been increasingly popular for exterior and interior projects. Made to custom lengths in all of panels – including the 1-1/4-inch and 2-1/2-inch corrugated panels, ABM Panel, and 16-1/2-inch-wide ABSeam Panel. Get inspiration at abmartin.net/aged-metal. Order today!

www.abmartin.net

ABC Supply Company, Inc.



ABC Supply Co. Inc. is the largest wholesale distributor of roofing in the United States and one of the nation's largest wholesale distributors of select exterior and interior building products. The company carries a broad portfolio of steep- and low-slope roofing materials, insulation and accessories. This includes products such as asphalt, concrete, clay, slate and composite roof shingles; cedar shakes; metal roofing; single ply, built-up, modified bitumen roofing and more.

www.abcsupply.com

American Building Components

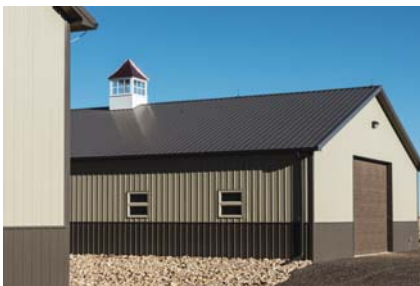

American Building Components (ABC) has built a strong reputation of providing an expansive variety of premium 29- and 26-gauge metal roof and wall panels and trim that customers have relied on for more than a century. Supported by a nationwide network of manufacturing facilities and distributors, the company's painted steel is backed by industry-leading warranties that assure your projects will stand the tests of time. ABC products are available to order online.

www.shop.abcmetalroofing.com

Ramco Supply

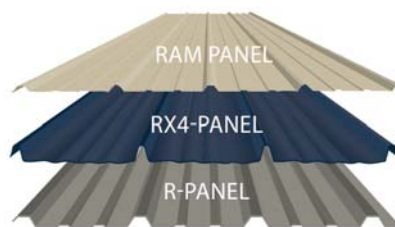

Ramco Supply manufactures metal roofing panel systems. Standing seam roof profiles, exposed fastener and concealed fastener panels are available in a variety of substrates, gauges and colors, along with accessories, including DripStop. Ramco has developed a unique system that allows same-day pick-up of custom length metal roofing and siding, or Ramco can deliver and unload on-site in 48 hours. Save money by completing your project more quickly and easily with less damage!

www.ramcosupply.com

Central States Manufacturing



Central States manufactures metal buildings and components for the post-frame, light-gauge, architectural, residential and commercial markets. Offerings include both exposed and concealed fastener panel profiles, as well as trapezoidal standing seam panels in a selection of gauges, colors and warranties. Trim and purlins are also available. Complete mini, boat and RV storage packages are available through the Central Storage Works division.

www.centralstatesmfg.com

Petersen Aluminum



Petersen's SNAP-CLAD metal roofing panels feature architectural panel aesthetics and structural panel performance. SNAP-CLAD panels are available in over 45 colors and steel and aluminum. The 70 percent PVDF finish is covered by a non-prorated 30-year warranty. Most colors meet LEED®, ENERGY STAR® and cool roof certification requirements. For information about Petersen's full product line, visit PAC-CLAD.com or call 800-PAC-CLAD.

www.PAC-CLAD.com

Metal Panels Inc.



Metal Panels Inc. offers more than 19 profiles of quality metal roof and wall panels, all available in durable finishes and energy-saving cool colors. MPI panels are produced with one of the quickest turnaround times in the industry. Exposed and hidden fastener panels, custom trim, accessories and flat sheets are available from MPI locations. MPI serves a Midwest seven-state region through manufacturing centers in Oklahoma and Kansas.

www.metalpanelsinc.com

Everlast Roofing Inc.



Everlast Roofing's metal and siding products are uniquely made with a one-of-a-kind heat-forming process that prevents microscopic paint cracks. This enables the use of harder, more scratch-resistant paints. Offering a variety of gauges, colors and custom trims to suit every customer's application makes Everlast Roofing the perfect choice for the agricultural, commercial and residential markets.

www.everlastroofing.com

McElroy Metal



Designed for post-frame and residential applications, the Mesa panel is a patent- and copyright-protected panel with a nearly invisible lap. The Mesa panel is sure to add beauty to any project, measuring 36 inches wide with 3/4-inch high ribs. McElroy Metal, a leading supplier of metal wall and roofing products to the post-frame industry, is a participating supporter of the National Frame Building Association. McElroy Metal is a 35-time winner of the *Rural Builder* Gold Key of Excellence, as selected by readers.

www.mcelroymetal.com

Graber Post Buildings



Graber Post has everything for a post-frame structure or metal panels for any residential, commercial, industrial, agricultural or roofing application. Graber Post also produces custom trusses, metal trims, laminated poles and also has a steel coil division. GPB saves time and money by supplying all needed materials with just one phone call. Wholesale customers/distributors are desired.

www.graberpost.com

Extrutech Plastics



The Extrutech Plastics "stay-in-place" concrete form for poured walls is pre-cut to project specifications and snaps together with a double-spline E-locking system. The Extrutech FORM offers an easy-to-clean sanitary surface on both sides. The product creates a structural wall system that is builder- and customer-friendly for use in dairies, car washes or food facilities. Initially designed for 6-inch poured walls, it is also now available for 8-inch walls.

www.extrutechplastics.com

Dynamic Fastener



Dynamic Fastener's Dyna-Guard snow retention system is designed to be used on virtually any style metal roof. Dyna-Guard is an 8-foot long extruded aluminum rail with a T-shape profile. Dyna-Guard is installed by attaching non-ferrous clamps or mounts to a metal roof and bolting or screwing the system to clamps or mounts. Eight Dyna-Clamps with round-point stainless steel set screws and Sno-Dams are also offered. Sno-Dams attach to the back of Dyna-Guard and inhibit snow and ice from sliding underneath. Dyna-Clips are available as a Dyna-Guard to Dyna-Clamp connection device when using unpunched Dyna-Guard. A 2-inch wide painted strip of metal from the same material as the roof is inserted in the Dyna-Guard for aesthetics.

www.dynamicfastener.com

Midwest Enterprises



Hydroclean® High Capacity gutter guards are engineered for heavy rain volume areas where the perforated surfaces work hard to channel away excess rainwater. Best on long runs of standard shingles, very steep roofs, and metal roofs, the 5-inch guards have 3 rows of perforations, where guards for 6- and 7-inch gutters have 6 rows – to handle even greater volumes.

www.e-zgutter.com

AceClamp



The AceClamp Snow Titan is AceClamp's strongest and easiest snap-together snow-retention system on the market. The cantilever "gripping claw" offers the latest in clamping mechanisms for easy installs with confident gripping power. The triangular rail handles extreme snow loads with confidence. The patented "sliding-pin" design Ace clamps help protect the panel and warranty and come standard with any of A2 style Snow Titan snow-retention systems.

www.aceclamp.com

ST Fastening Systems



ST Fastening Systems offers Snow Trax snow retention guards for exposed fastener roofs and the MRC Snow Trax roof clamp for standing seam roofs. The Snow Trax is 16 gauge 304 stainless steel available in more than 20 powder coated colors. Its adhered rubber gasket eliminates the need for additional sealant. The MRC is extruded aluminum, and a colored rail slides through the clamp grooves to provide maximum protection from snow and ice.

www.stfasteningsystems.com

Raytec Manufacturing



HangTite and HangFast hidden gutter hangers, manufactured by Raytec Manufacturing, are exceptionally strong. Both have proven records of performance, strength and ease of use in the field. Raytec engineers designed the Hangtite to be strong. Hangfast hangers, with the integrated screw, add speed to the installation without compromising performance. Both hangers are available in 5-inch and 6-inch sizes, in aluminum, galvanized and copper.

www.raytecllc.com

Levi's Building Components



Levi's Snow Defender 4500 answers your snow retention needs with high quality and good looks. Made of 16-gauge 304 stainless steel, it is designed for performance and long life. Using the highest quality powder coating process, the 4500 is available in more than 40 colors, matching most metal roofing manufacturer's colors. Backed by the product-specific Snow Defender Calculator, to ensure proper placement for best performance, the 4500 is your best choice for snow retention.

www.levisbuildingcomponents.com

ONE WEBSITE HAS IT ALL!

Search for products, companies, past articles, industry news, Buyers' Guide, product profiles, renew your subscription or start a new one!

Sign up for email newsletters designed for rural builders, metal roofers and roll formers.



**Rural
Builder**

**METAL
ROOFING
MAGAZINE**

**FRAME
BUILDING
NEWS**

**Rollforming
Magazine**

FROM THE PUBLISHERS OF

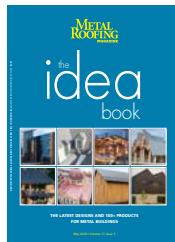

www.constructionmagnet.com

Tools & Equipment

SUPPLIES AND SOLUTIONS

ASC Machine Tools, Inc.



The ASC Alpha Series® is a new revolutionary panel roll-forming line featuring heavy duty cast stands with cast bearing blocks. The close-coupled pre-cut front-end minimizes the equipment footprint to a total length of approximately 40 feet. The additional slitter pass and belt conveyor option allows the economic production of flat sheets and trim blanks — both exiting at a convenient height of approximately 30 inches. The Alpha Series is also available as a post-cut line featuring rugged hydraulic post-cut shear to produce panels down to 1 foot in length.

www.ascmt.com

The Brut Post Grabber



The Brut Post Grabber attaches to any skid steer, eliminates hole sloughing, provides quick and precise post and pole placement. It shortens the time it takes to set a post or pole and is virtually effortless. The Brut Post Grabber is very affordable, saving time and man hours. It easily positions posts and poles — even in sinking or soft soil — and is perfect for setting Perma Columns. Plus, the Brut Post Grabber is the safest way to set poles and posts — it virtually eliminates injuries.

www.thebrutpostgrabber.com

GutterBrush Leaf Guard



GutterBrush is the simple, affordable gutter guard guaranteed to keep gutters flowing. Quickest installation that requires no tools, fasteners, or cutting and doesn't interfere with existing roof or gutters. GutterBrush is available in 5 diameters (3.25-8.0 inches) for just about any residential, commercial, or industrial gutter sizes. Request your free samples today! Made in the USA, performance and satisfaction guaranteed. Discounted pricing and free shipping for builders. Contact us! 888.397.9433

www.gutterbrush.com

Dynamic Fastener



Dynamic Fastener offers a variety of professional tools by DeWalt, Milwaukee, Bosch, Hitachi, Fein, Trumpf, Olympic, Makita, Metabo, Skilsaw and Kett Power Tools, as well as Klein, Proto and Crescent Tools, bolt bags and leather goods. Also offered are DBI Sala, Preferred Safety and Guardian fall protection; plus hard hats, safety glasses and hearing protection. Same-day shipping is available for screws, anchors, flashings, safety equipment, hand tools, and power tools. A free 140-page, full color, tool and fastener handguide provides engineering data, and details product offering.

www.dynamicfastener.com

Paint Valley Parts Ltd. / Acu-Form



Deluxe Perforator double pass has profiled center dies to hold material and makes a nice straight perforation. All the perforator dies designed with D2 steel for longer wear life, as well as the ability to sharpen if the need arises. The dual entry guides can be adjusted to run flat strips for trim pieces. This machine can be powered by electric, hydraulic, or mechanical.

acu-form@safecommail.com

Rollformer Corporation



Roll Former Corporation has been in business since 1978. For 41 years it has designed and manufactured machinery for the metal roofing and construction industries. Today it offers more than 25 standard product pieces of equipment. For the last 29 years it has been producing "custom profile" machines. Call, fax or email the machinery profile that you need to expand your business. Made in the USA.

www.rollformercorp.com

New Tech Machinery



The newly configured NTM SSQ II™ Roof Panel Machine is the original, best-selling SSQ, but now with added functionalities to make it the most versatile machine available. New features include notching capabilities: notches (square and profiled) are punched before the legs are formed for a cleaner cut; angled slitting: allows panel cutting at any angle from 90-35 degrees; NTM200 Controller; and specialty profiles. The SSQ II comes with 15 quick-change profile options, 45 minutes or less tooling changes, and one of the industry's best warranties.

www.newtechmachinery.com

GutterSupply.com



GutterSupply.com is your partner for roll forming machines. We specialize in metal roof panel machines and gutter machines. We offer the industry's lowest pricing, as well as additional credits back for factory training. Our customers can customize their machines to fit their needs or buy the complete package for additional savings. Contact us today to find out which machine best suits your needs, and ask about our financing options.

www.guttersupply.com

Hershey's Metal Meister LLC



Wouldn't you like to have the same kind of quality and service that you strive to deliver to your customers? Variobend USA is the answer to your quest for speed, accuracy, and service in a trim folder. European design coupled with American manufacturing and service, Variobend USA folders are built with you in mind. Look no further! Contact Hershey's today to experience it for yourself! Need more proof? We are happy to let you talk with Variobend USA owners. 877.289.3030.

info@HersheysMM.com

Bradbury Company, Inc.



The Bradbury B.O.S.S.™ Series is a state-of-the-art roll former and closed-loop servo shear with speeds up to 300 FPM and accuracy of 1/16". The B.O.S.S.™ can be close coupled to a new or existing roll former and is the leader in high production panel line roll forming.

www.bradburygroup.com

Hayes International



Hayes Single-Level™ roll formers provide a highly cost-effective roll forming line for roofing panel profiles. An integrated uncoiler and stationary shear are standard equipment. Hayes Dual-Level™ roll formers share the same basic design as the single level models but produce two profiles within the same floorspace. They have two levels of dedicated tooling, top and bottom in-feed guides, a double-acting stationary shear, and twin independent drive units.

www.bradburygroup.com

Bradbury Group Australia



Whether you require residential or commercial ridge caps, low or high rib corners, sculptured rakes, or J or jamb trim, Bradbury Group Australia's multi-profile trim roll formers give you profile flexibility while saving floor space. BGA is your reliable source for trim and rainwater component production equipment.

www.bradburygroup.com

index of advertisers / classifieds

RS #	Company	Page
291	AB Martin.....	18
435	Bradbury Group, The.....	58
386	Cannonball: HNP LLC.....	23, 61
403	Chief Buildings.....	35
	Clark Industries.....	58
	Direct Metals.....	CVR
581	Dura Coat Products.....	7
316	Dynamic Fastener.....	76
585	EPDM.....	61
407	Everlast Roofing, Inc.....	15
	Extrutech.....	58
359	Fasco America.....	31
288	GSSI Sealants.....	31, 61
536	Hershey's Metal Meister.....	19
341	Leland Industries Inc.....	61
392	Levi's Building Components.....	69
	Marion Manufacturing.....	58
306	Maze Nails.....	CVR, 2
584	Metal Rollforming Systems.....	18
412	MFM Building Products.....	49
308	MWI Components.....	25, 61
	Paint Valley Parts.....	CVR, 58
	Plasti-Sleeve.....	58
313	Plyco.....	5, 61
595	Raytec Manufacturing.....	17
382	Rigidply Rafters.....	CVR, 13
442	Roll Former Corporation.....	33
208	Sims Steel.....	61
429	ST Fastening Systems.....	27
375	Starwood Rafters.....	49
345	Sukup Manufacturing.....	9
559	Trac-Rite Doors.....	21
564	United Steel Supply.....	61
511	Wick Buildings.....	29

SHARE YOUR POSITIVE PRESS WITH A REPRINT TODAY!

Let us help you showcase your article by creating high-quality reprints. Positive press like this should be shared to maximize your company's exposure. Use your reprint for endless marketing opportunities such as trade show literature, press kits, direct mail and post a digital copy on your website. Include your company logo and contact information.

FOR A CUSTOM REPRINT QUOTE CALL

Gary Reichert
gary@shieldwallmedia.com
715-252-6360

ROLL FORMERS



- | | |
|-------------------|-----------------------|
| Panel Lines | Portable Roll Formers |
| Purlin Lines | Insulated Panel Lines |
| Control Retrofits | Standing Seam Lines |
| Hydraulic Folders | Garage Door Lines |
| Trim Roll Formers | Slit & Recoil Lines |



www.bradburygroup.com 620.345.6394

ROLL FORMERS



- Automation Systems
- Metal Construction Rollformers
- Coil Processing
- Forming & Fabrication
- Recondition Existing Machines

WE ADD THE VALUE TO METAL

1-888-865-8740 www.marionmanufacturing.com



ROLL FORMING EQUIPMENT

- | | |
|----------------|------------------|
| Ag Panel | Hemmer |
| Post Cut Shear | Trim Rollformers |
| Pre Cut Shear | Wrappers |
| Uncoiler | Upenders |
| Slitter | Perforator |



We use D2 tool steel as a standard.

Phone (330) 674-4003 Fax (330) 674-4035

TIMBER COLUMNS

PLASTI-SLEEVE®
POST PROTECTION
TYPICAL POST FRAME DESIGN

The "Original" post protector

- Low cost - Easy slide on
- Made from the best, HDPE black plastic!

sales@plastisleeve.com
Toll free 877-775-3383
www.plastisleeve.com

MISCELLANEOUS

Clark Industries, Inc.

Since 1967 - Monett, Missouri

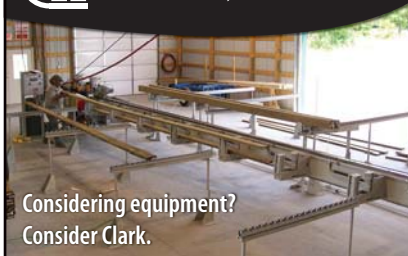

- Roof & Floor Truss Presses
- Multi-Head Truss Presses
- Modular Truss Presses
- Shuttle Presses
- Jack Presses
- H.D. Chord Splicers
- Post & Column Machines
- Floor Truss Machines
- Electric Horizontal Stackers
- Electric Peak-up Stackers
- Conveyor Systems
- Custom Machinery

Call us toll free at: 800.743.9727
or visit us on the web at: www.clark-ind.com

Wall and Ceiling Panels and FORMS



- Stay-in-place concrete wall FORMS
- Non-Porous - Sanitary - Smooth - Easy to Clean
- 6" and 8" FORMS Panels now available
- For Corrosive or High-Moisture Areas
- Made in the USA



View our New FORM Panel video on our website

888-818-0118



www.epiplastics.com
email: info@epiplastics.com



EXTRUTECH PLASTICS, INC.

Swenson Shear



Manufactured by Swenson Shear, the Towable SnapTable Pro is the all-in-one panel preparation system for standing seam metal roofing. It accommodates panels between 12 inches and 24 inches and is equipped to notch, cut, and hem up to 60-inch offsets for hip and valley roofing cuts. The Towable SnapTable Pro provides the highest quality notching, cutting, and hemming for any commercial, industrial, or residential job.

www.swensonshear.com

Metal Rollforming Systems



Metal Rollforming Systems (MRS) designs and manufactures industry-leading roll forming equipment and accessories. MRS' product lines consist of single- and double-deck roll formers, single- and multi-trim roll formers, slitters, and more. MRS takes great pride in customer support both before and after the sale.

www.mrsrollform.com

Recall Notices

DEWALT UTILITY BAR

On September 26, 2019, DeWalt voluntarily issued a recall notice of the DeWalt Model DWHT55293 40-inch Multi-Functional Utility Bar. The bar can break during use, creating an injury hazard. The only bar affected by the recall is the above-mentioned model.

Those who have an affected bar can call 866.937.9805 between 8 a.m. and 5 p.m. Eastern Time Monday through Friday, or email recall@sbdinc.com to receive return instructions and receive a gift card equal to the purchase price.

GORDON FOLDING KNIFE

Harbor Freight Tools voluntarily issued a recall of about 1.1 million Gordon Folding knives. The knives were sold at Harbor Freight Tools stores, by telephone, and online at www.harborfreight.com from July 2008 through July 2019 for about \$5.

The locking mechanism can fail to engage on the extension of the blade, posing a laceration hazard.

Consumers should immediately stop using the recalled knives and return them to Harbor Freight Tools for a \$5 refund in the form of a store gift card plus sales tax. For more information, contact recall@harborfreight.com or 800.444.3353.

IN-FLOOR ELECTRICAL OUTLET KIT

The Southwire Company has issued a voluntary recall of about 3,000 Garvin Pop-Up Electrical Outlet Floor Box Kits. The pop-up electrical outlet boxes are designed to be installed into floors with a metal lid that opens and closes to reveal the electrical receptacles and USB ports.

The stainless steel or brushed brass-finished electrical receptacles can overheat when in use, posing a fire hazard.

The kits, which were manufactured in China, were sold online at garvinindustries.com, acdcusa.com, cesco.com, gordonelectricsupply.com, platt.com and usesi.com from January 2016 through August 2018 for about \$90.

Those with the kits can call 888-803-0492 from 7 a.m.-6 p.m. Central Time Monday through Friday (or visit www.garvinindustries.com or www.southwire.com)

Rustgo



The Rustgo Mobile Work Platform models allow up to six workers, on three levels at varied heights, multiplying their effectiveness as they roll down the side of your job. No scaffolding. No CDL driver needed. No trailer needed. No motors to maintain. Super low maintenance. Just tow the Rustgo behind your truck to your job site. There is no better tool for reaching your goals and cutting costs. Made in the U.S.A.

www.rustgousa.com

Marion Manufacturing



Marion Manufacturing adds the value to the metal by designing, fabricating, and installing custom manufacturing and production machinery. Marion specializes in metal-forming equipment such as roll formers, uncoilers, shears, stackers, etc. Marion Manufacturing also offers a full-service machine shop and re-tooling and service on other brands of equipment.

www.marionmanufacturing.com

Marco Industries



As North America's leading ventilation manufacturer Marco Industries offers superior roof ventilation your way, with products tailored to fit your specific performance requirements and budget. Our ventilation products feature an exclusive nonwoven polyester material that delivers extreme durability, and breathes to help prevent moisture absorption. All ventilation products offer a 40-year limited warranty, easy one-person installations, and two full beads of M63, Marco's proprietary adhesive, for superior hold.

www.marcoindustries.com

Plyco Corporation



Plyco manufactures and distributes a variety of ventilation products designed to meet most airflow requirements. The MWE-100 is a low profile unit, 10 feet in length with 12 square inches of free air space per lineal foot. The MW100-25 has a higher profile than the MWE and is open at the top. The ventilator has an internal diverter to direct rain off to the side and out onto the roof. The MW100-35 has the same design as the 25 series with increased free air space of 36 square inches per lineal foot. The FMW100-35 is of the same design as the 35 series but the diverter is made from translucent fiberglass to allow light into the building ridge while keeping the rain out.

www.plyco.com

MWI Components



MWI supplies Uni-Vent II and III to ventilate with a ridge cap, and they manufacture five Ridg-Vent profiles. Additionally, MWI offers over 100 colors for Ridg-Vents to match most roll-formers' metal panels. The Ridg-Vents' metal edges are hemmed for easier handling/improved strength. Their lack of raw metal edges prevents rust stains. MWI also manufactures steel/aluminum soffit systems. Pre-cut or special-cut lengths are available - sizes 7" to 144". When united, Ridg-Vents, Uni-Vent, and soffit provide superior ventilation.

www.mwicomponents.com

CannonBall:HNP



PROFILE CUT VENTING MATERIAL

CannonBall is offering FlexPro venting material, with protection that lasts like no other. Offering 40 years of warranted weather-tite performance, this recycled-material polyester prevents moisture absorption and holds together longer than standard polyurethane venting products. Available in 20-foot rolls to ride with CannonBall product shipments, FlexPro provides the durability and element resistance to meet building codes, reduce damage and save on costs.

www.cnbhnp.com

Carrington Building Products



Adequate roof ventilation and uniform airflow are critical for the proper maintenance of metal buildings. Carrington's patented Dri-Vent and Dri-Vent2 vented closure strips are rugged, breathable, easy-to-install solutions to ensure adequate ventilation for metal roofs. Dri-Vent and Dri-Vent2 closures provide the ideal balance of superior venting, rugged construction for long life and budget-friendly cost.

www.carrington-specialty.com

ST Fastening Systems



ST Fastening Systems supplies its MultiVent and MultiVent10 closures for those applications requiring airflow on metal roofs. Open cell foam MultiVent, 3 feet in length, and woven polyester MultiVent10, 10 feet in length, allows as much as 98 percent free airflow through the material. However, it prevents wind-driven rain from penetrating the material when compressed. The designs are universal for both, with adhesive applied for easy field installation. MultiVent can be used on angled roof applications and MultiVent10 for ridge cap applications.

www.stfasteningsystems.com

business connections

Find all your building products today!

800.360.6467 | BUILT FOR POST FRAME | 712.262.1372



MWI COMPONENTS

NEW SITE: MWICOMPONENTS.COM



CRS #308

FIX ROOF LEAKS GUARANTEED

THE ONLY LIQUID EPDM RUBBER IN THE WORLD!

25 YEAR HISTORY OF SUCCESS | **EPDM coatings**

WWW.EPDMCOATINGS.COM PHONE: 610.298.1989

CRS #585

INTRODUCING THE ALL NEW PATENTED READY COLUMN™ SYSTEM

Cut & fit columns on site with our patented locking base system. No more waiting for lally columns. Just cut to length, assemble and install.



SIMS  

www.readyheader.net • 631-587-8714

CRS #208

Strength in all Seasons

Since 1951, Plyco has stood by you and by their products. Plyco offers a complete line of entry doors that surpass building codes and customer expectations. **Build Plyco Strong.**

800.558.5895 • www.plyco.com



PLYCO

CRS #313

UNITED STEEL SUPPLY

STEEL PRODUCTS FOR THE METAL ROOFING & METAL BUILDING INDUSTRY

Understanding Superior Service



512-263-0954 • unitedsteelsupply.com

CRS #564

GSSI SEALANTS

PREMIER BUTYL SEALANT TAPES

RAIN'S WORST ENEMY

800.288.9489 GSSISEALANTS.COM



CRS #288

LELAND INDUSTRIES INC.

T 1.416.291.5308
1.800.263.3393
info@lelandindustries.com
lelandindustries.com



100% North American Fastener Manufacturer

CRS #341

800-766-2825 • Beloit, WI www.cnbhnp.com

CANNON BALL Original producer of round track and trolley sliding door systems.

The leading post-frame and metal building product supplier

- Door Track Systems
- Builders Hardware
- Sliding Door Systems
- Horse Barn Systems
- Walk Doors
- Windows
- Ventilation
- Building Materials



CRS #386

Windows • Skylights • Daylighting

SUPPLIES AND SOLUTIONS

Rural Builder

CannonBall:HNP



CannonBall offers a variety of window applications for agriculture, commercial and metal building markets. The thermally-broken 2200-Series aluminum windows hold off winter's cold and are available in slider, hung, fixed, and architectural shapes. Value models can be found in the 1200-Series welded vinyl construction and wide assortment of horizontal sliding, single hung, 3-lite slider, fixed and architectural shape configurations. Specialty glass is available in both series upon request.

www.cnbhnp.com

Palram Americas



Palram continues to expand its SUNSKY Polycarbonate Panel line, allowing builders to offer more day lighting and side lighting options to their customers. With Palram's proprietary MetalMatch Technology, Palram can match virtually any corrugated metal panel profile available, with minimal order requirements. Palram also offers a complete line of AG-TUF and DURACLAD PVC liner panels for interior use.

www.palramamericas.com

Plyco Corporation



The CTB (Commercial Thermal Break Window) is Plyco's top-of-the-line commercial quality window. It is constructed of 100 percent thermalized aluminum extrusions with 3/4-inch thermo pane glazing. AATL (All Aluminum Trimline) windows, an aluminum frame window, is specifically designed for the metal-clad building industry. Series 100 energy efficient window is made of "Fibrex," a revolutionary composite material with strength, aesthetic appeal, and energy efficiency (Energy Star). The Series 100 window can be painted and holds its form without warping or twisting.

www.plyco.com

A.J. Manufacturing



A.J. Manufacturing offers a complete line of durable high-quality aluminum, Harmony vinyl and Main Street vinyl windows. Options include standard and custom colors, horizontal sliding, fixed lite, casement, single hung, double hung, architectural shapes, grids, and Low-E glass. White, brown, bronze, champagne, clay or custom-colored windows and trim will enhance the appearance of your next building.

www.ajdoor.com

Direct Metals Inc.

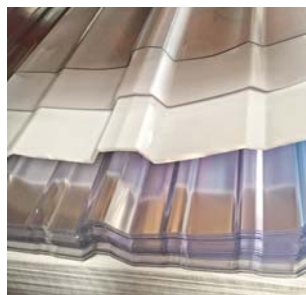

Direct Metals Inc. (DMI) distributors have the flexibility to offer many choices in daylighting options including profiled and flat monolithic translucent panels. Profiled panels are available in different strength ratings and thicknesses: 1.0mm, 1.5mm and 2.0mm. Custom panel profile-matching technology is available to your customers where DMI can create a custom translucent panel using your CAD drawing (minimum orders apply). All panels are co-extruded with UV protection and offer a 10-year warranty against loss of light transmission due to yellowing and against damage due to hail.

www.directmetalsinc.com

ABC Supply Company, Inc.



ABC Supply Co. Inc. is the largest wholesale distributor of roofing in the United States and one of the nation's largest wholesale distributors of select exterior and interior building products. The company carries the top brands and latest products in replacement and new construction windows, skylights, and glass doors. Since 1982, ABC Supply's sole focus has been serving professional contractors.

www.abcsupply.com



See You In Queen City!

REGISTRATION OPENS FOR CONSTRUCTION ROLLFORMING SHOW

THE FIRST ANNUAL CONSTRUCTION ROLLFORMING SHOW IS OPEN FOR BUSINESS. Registrations for trade show admittance and educational programming are now being accepted.

The December 12-13 trade show, which focuses solely on the metal roll-forming industry, will be held at the Duke Energy Convention Center in Cincinnati. Premier show sponsors include Acu-Form Roll Forming Equipment; ASC Machine Tools, Inc.; MWI Components; AMS Controls; and Hershey's Metal Meister, LLC.

Roll-formed metal wall and roof panels comprise a large part of the agricultural, commercial, post-frame, and residential construction markets. It is a rapidly growing — but previously underserved — segment of the metal construction industry.

The event's new owner, Shield Wall Media, remains steadfast and enthusiastic after purchasing the show from F+W Media. Publisher Gary Reichert said, "Less than a year ago, we debuted the premiere issue of *Rollforming Magazine* at METALCON. And now, just a short while later in the grand scheme of things, the registrations are open for the premiere trade show devoted exclusively to roll forming.

"There is strong anecdotal evidence from manufacturers and component suppliers that this specific niche in the construction industry is growing," Reichert continued. The environmental factors also point to growth. As asphalt prices increase, the investment gap between a traditional asphalt shingle roof and a more durable metal roof closes. As various types of metal roofing becomes more competitive, the additional demand results in more manufacturing.

"This segment has been ignored for too long. One of the tasks facing *Rollforming Magazine* and the Construction Rollforming

Show is generating actual market data," he explained.

The Construction Rollforming Show is targeted to an audience of medium to large builders, dealers, distributors, and manufacturers. During this special event, more than 50 exhibitors will fill the 15,000-square-foot show floor. From raw materials to automation software, exhibitors will feature products and information to support all facets of the roll-forming industry.

In addition to a trade show, the Construction Rollforming Show includes educational programming tailored specifically to roll formers. The education package includes presentations on inventory control and management, improving quality and productivity, coil and steel metallurgy and properties, paint and coating technology, business best practices and development, with more sessions yet to be added. Of significant note is a special presentation on Friday, December 13, which focuses on industry metrics on roll forming in the construction industry and its potential for growth.

Two registration options for the Construction Rollforming Show are available. Admission to the trade show is \$45, while trade show admission *plus* admission to all the educational opportunities is \$150. To register, visit <http://bit.ly/RFSHow2019>.

The Duke Energy Convention Center is located at 525 Elm Street, Cincinnati, Ohio. Special discounted room rates are available at the Hyatt Regency Cincinnati; to receive the discount, you must mention The Construction Rollforming Show when making your hotel reservation. (Reservations: 513.579.1234)

For more information about the show, including remaining exhibition and sponsorship opportunities, contact Gary Reichert at gary@shieldwallmedia.com or 715.252.6360. **RB**

Construction
Rollforming
Show 2019

Planning For A Successful Build

Avoid self-storage development mistakes

WELL, YOU HAVE FINALLY gotten all your approvals for your self-storage project. It has taken you at least two to three times as long as you thought, and to top it all off, you had to agree to a bunch of additional items the city required that you are still trying to figure out how to pay for.

Now you are finally ready to build. Next, you are either pulling the trigger with hiring a general contractor to build your site or you are planning to be your own general contractor and start building. This article is written assuming that you are going to be your own contractor because it will be the worst-case scenario for you. (Yes, that means it is all up to you to figure out your mistakes.)

SITE PREPARATION

The single biggest development mistake of building a self-storage is to not have the proper grading in place. This means that you have water properly flowing off your pavement to your new retention pond. I know you have a grading plan in place from a licensed civil engineer, but once you work your site and try to determine final grades (there are always field changes that have to be made) you will then determine if the plan will actually work.

What specifically you are looking for is if you have enough pitch to drain your water correctly. For example, if you are using asphalt you will want to have your water drain at a 1 percent pitch, but if you have a concrete drive you can reduce slope to 1/2 percent. The greater the slope the better it is for drainage. Many people regret not installing underground storm drains including pipes from the gutter spouts. This option costs more but you will always be happy you did it in the long run.

Speaking of grading and dealing with precipitation, a related

mistake is to drain water to the north side of the building in any climate with ice and snow in the winter months.

PLANNING CONDUIT RUNS

Failing to properly plan and install all the underground conduit you will need for your project can be another major mistake. This sounds like a minor item, but it is extremely important.

The first conduit line that will go from your office building to your self-storage buildings will be for power. Normally you will need at least a 1-1/2-inch conduit going to each building so that you can have power for outside lighting. If you are going to have a climate-controlled building, you may require a larger pipe for the extra power needed for HVAC systems.

In case you are phasing your project, and do not know exactly what building you may be doing next you will want to oversize the pipe and make sure the conduit extends *beyond* the pavement you are doing in the first phase.

The second conduit layout you should be working on is for your camera system. This low-voltage conduit must be separate from the electrical conduit to reduce interference from the higher-voltage power lines.

The last conduit you will need to work on is for the controlled gate access system and keypads. The location of this conduit will be determined by where you are installing your gate system.

GATE PLACEMENT

Poor gate placement is another common mistake. The ideal spot for the gate will allow for the customers to be off the road while putting in their gate code. The actual gate should be at least 12 feet in front of the keypad so there is a better chance



Properly preparing the build site is an important step to a successful project.



Site prep and foundation work for a two-building, 20,000 sq. ft. climate-controlled storage building expansion. Planning for stormwater handling and underground utilities for current and future phases is an important part of self-storage development.



that your customers will not run into the gate. Customers should be able to access the office (or automated kiosk, if applicable) and should have room to turn around and leave without going through the gate.

I believe whether or not you are planning to put in a gate now or possibly in the future, you should always figure out the exact gate location. The location of the gate may change what type of gate you will need for your project. In many situations, the best location will force you to install a vertical lift gate instead of a sliding gate. Of course, the vertical lift gate costs a lot more than a slider, but it may be the best type for your situation.

INSTALLING THE FOUNDATION

We are now ready to install your foundations. I suggest that you have your site surveyor stake out the building corners to make sure you are setting the building into the correct spot. This costs extra money, but it is invaluable to make sure all the buildings are properly positioned and at the correct floor height.

While you are constructing, you may run over the grading stakes; it costs more money, but have your surveyor come out again — it minimizes the chances for a mistake.

I'm a firm believer to also verify the building foundation dimensions before concrete pouring is started. A typical mistake is that the concrete contractor does not have the correct building width (they took the dimension from the outside of the form, not from the inside where the concrete will stop).

What happens more frequently is, if you have steps in the buildings, these may not be in the right spot or the correct height compared to the final site plan layout.

FINAL GRADING AND PAVING

Once your foundations are poured, then you can do final grading and possibly install your binder course of asphalt paving. Many people do this later (once the building is built)



Before pouring your concrete, make sure you have all the required conduits in place. This photo of Fern Ridge Self Storage (now completed and open) show an example of a well-planned and executed site, ready for steel buildings.

but some still pave before the building is installed so that they will not have their asphalt paving contractor hit the building. Whatever the case, you will want to have all bollards installed before paving. ALWAYS install bollards on all four corners of your building, these bollards should be a minimum of 6 inches wide and 3-4 feet into the ground so they are normally a total of 7 feet long when purchased. You will also want to install bollards on all sides of your keypads, and on the corners of your gate so that you will be protecting your investment. I have now started to put bollards at all my recessed openings into hallways. Many people seem to back into these areas, so it is good to protect against them hitting them. If you are building large Boat/RV commercial units then you may want to put in bollards in front of each of the door jambs. This is an expensive proposition, but it will help defend against damage in the future.



Bollards should be installed at all building corners to protect your investment against damage.

OFFICE SPACE

One of the biggest regrets people have had with their self-storage development is that they wished they would have built a nicer office. I believe it is very important to put all the extra money you have into making your office as beautiful and as spacious as you can. The extra touches in design and finishes always pay off in the long run. Good planning up front is key. If all the parts are detailed then you will just need to hire good finish carpenters to implement the plan. Make sure the office has a unit next to it to store equipment/electric cart/maintenance items. Preferably this area is also heated; it will be helpful in keeping the site clean and in good order.

FINAL INSTALLATION

When the actual building is installed you will want to verify that the building is going up according to plan. Make sure to do a proper walk through with the installer to make sure all the doors are in proper working order, that there are no missing screws in a wall panel, etc. Remember, it is easier to fix any issues up front than find out about them afterwards when you have started to rent a unit.

In your buildings that have hallways, I recommend planning an area that will accommodate the carts needed to move your customers' possessions to their unit. I have seen many times these carts just left in the corridor and can become an obstacle

for the customers. Having an area for them set aside out of the way is a better plan.

BE READY FOR BUSINESS

Lastly, don't get so caught up with the physical construction that you miss important property management details. I recommend that people pull a permit for each building separately. The reason for this is that you can get a certificate of occupancy per building. This means when you have one building done you can start renting. In many areas, if you pull only one building permit that means all the buildings must be completed before you can rent one unit. Many customers are so worried about getting the building built they are not actually ready to rent a unit. It is wise to have your website and management software system already in place, for example. Don't forget to submit your business details to major search engines so customers can find you. Set up your accounting software, before opening, and if possible work to integrate it with your management software. You will need to be set up to take credit cards, and your banking should be ready to go, including taking ACH payments.

You have been working for many months — if not years — getting ready for this point of actually collecting money. It is surprising to see how many people are not prepared for the day they can actually start earning some money. **RB**

BY JAMIE LINDAU, TRACTE BUILDINGS

Developing A Storage Unit Mix

Planning Unit Location, Sizes, and Quantity

ONE OF THE TOPICS frequently discussed by new self storage developers is unit mix. And for good reason – building the right units can be the difference between renting up a good pace at full price vs renting up slowly and discounting.

Your exact unit mix and layout will be influenced in part by the layout of your property, and how the buildings will fit. But even before you start worrying about how the buildings fit on the land, you should be investigating the neighborhood to determine what kind of storage is most likely to succeed.

START WITH THE COMPETITION

Secret shop your competitors and evaluate their pricing. Are there unit sizes that they do not have available? You might want to go heavier on that size. Do they ever discount specific sizes? They might have too many of those. It's common to see established storage businesses add buildings over the years — pay close attention to what they are adding, because that will tell you what rents well for them.

RENTERS OR HOMEOWNERS?

Customers tend to rent from the nearest facility, so locating land close to residential development is important. The type of residential development can help guide in unit size. Apartment residents tend to rent a smaller average unit size – commonly in the 5-by-10 to 10-by-15 range. Homeowners in the moving process will need larger units. They may rent a mid-size unit to begin staging their home, they move up to a larger or second unit. A homeowner moving a typical suburban four bedroom house can easily fill a 10-by-30, plus another unit.

DO THEY HAVE TOYS?

Some of your clients will be storing their power sports equipment: motorcycles, boats, jet skis, ATVs. Consider what type of activities are popular in your area, and plan to have units appropriate for them. When looking at storage for these items, think about the trailer too. In my area, 17- to 19-foot fishing and ski boats are popular. But don't be fooled into thinking that a 17-foot boat fits in a 20-foot unit. You need to factor in the motor hanging off the back and the hitch sticking out on the front of the trailer, as well as the width of the trailer wheels. Including some 12-foot wide units in areas with wider driveways can create some highly desirable units. In my area, boat owners would like 12-by-25 units with space to back them in.

Extra large units are increasingly in demand for campers and RVs, but you'll need to carefully evaluate the space required (the large units plus wide driveways) versus the rental income. Larger units tend to offer you a lower income per square foot. Angled parking or building designs can help reduce the land consumption, but in general its best to build smaller units if demand is there.

When considering whether or not to add boat and RV storage, observe if the local neighborhoods allow outdoor storage at residences. If homeowners are prohibited from parking the



Shopping competitors can help determine what size of units you should include in your own facility.

boats and RVs outside at home, you will have increased demand at your facility.

Over time you'll notice patterns in vehicle and boat storage – classic car owners (especially in the North) are likely to store their hobby cars in a self-storage unit during the winter, even though they might otherwise keep it in their garage at home. Why? Because they want to put their daily driver in the garage once the snow starts flying.

Providing electricity in units aimed at automobile storage can help justify higher rental income and attract a higher end client, however it does increase the risk for fire or attempts to live in a storage unit.

DO THEY HAVE BASEMENTS?

Regions without basements tend to have a greater need for storage. Areas with limited garage space also support increased long-term storage demand, compared to neighborhoods with three-car garages.



These are examples of well laid out sites with no dead ends. Gates are protected by bollards, and if equipped with an office, parking is available outside of the gated area.



WHAT IS THE TYPICAL CUSTOMER INCOME?

Higher income customers are more likely to be willing to pay for climate controlled storage. Additionally, they are more likely to expect a higher level of service – great lighting, higher end curb appeal, and other amenities.

IS THERE A COLLEGE NEARBY?

Students frequently rent smaller units. Additionally, younger renters are more likely to rent or reserve online. Once at your property, these renters are more likely to embrace technology in the form of a rental kiosk. On the negative side, student renters are typically seasonal renters with higher unit turnover.

HOW IS THE WEATHER?

In humid climates, climate controlled storage continues to increase in popularity. It offers customers better protection from mold and mildew and offers you as a developer better land coverage (assuming you build wider buildings) and return on your investment. In some areas it has become quite common, while in others there is an opportunity to be one of the first to market with this type of storage.

Are you building interior or exterior access units? If you project is a conversion or new climate controlled build-

ing, the unit mix can skew smaller, giving you more flexibility. At a traditional drive up site, you need some large units – for example, for a customer who needs to store a car or boat. But for interior units, everything needs to fit through the hallway. If a client needs 300 square feet of storage, it doesn't really matter if you rent him or her a 10-by-30 or two 10-by-15 units. Interior access projects rarely have units larger than 10-by-20.

Considering all the above, you'll be ready to proceed with your exact property layout once you've located the right parcel, balancing your anticipated unit mix with the mix that maximizes rental space on the property. If the project can be built in phases, that will give you the opportunity to adjust your mix as you grow.

Many new storage developers are interested in the idea of adjusting the wall between back to back units – for example you could change back-to-back 10-by-20 units into back-to-back 10-by-10 and 10-by-30 units. Or remove the wall entirely for a drive-through unit. While this certainly is one option for changing a unit mix, the easier solution is to adjust rates to encourage clients to rent your available units more evenly. This doesn't need to mean discounting: You could make your 10-by-20 units look more attractive by raising the rates on your 10-by-15 and 10-by-25 units. **RB**

industry news

BY RURAL BUILDER STAFF

■ CONSTRUCTION ROLLFORMING SHOW KEYNOTE SPEAKER ANNOUNCED

Shield Wall Media has announced John M. Rose will be giving the keynote address at the first annual Construction Rollforming Show in Cincinnati on December 12. Rose is currently the Chief Risk Officer at ALTOUR, one of the largest travel agencies in the world.

Rose has 22 years of experience as a C-suite executive in the insurance, assistance, and intelligence industries. His resume credits include serving five years as a Program Director for the Department of Defense.



John M. Rose

In his address, Rose will speak about competing in a rapidly changing global market, coping with disruptive change such as artificial intelligence, tariffs challenges, and finding qualified employees.

Attendee registration (\$45) is now open online at <https://www.constructionmagnet.com/construction-rollforming-registration>. (Online registration ends November 22. A \$25 fee will be added to ticket prices for walk-ins at the door.) To learn more about the December 12-13 Construction Rollforming Show programming, visit <http://bit.ly/CRSShow19>.

■ UNION CORRUGATING ACQUIRES OAKLAND METAL BUILDINGS

Industrial Opportunity Partners (“IOP”), an operations-focused private equity firm based in Evanston, Illinois, announced September 26 that its existing portfolio company Union Corrugating Company has acquired Oakland Metal Buildings. Oakland will operate as a plant location supporting the Union platform. Terms of the transaction were not disclosed.

Oakland is a manufacturer and distributor of pre-engineered metal buildings. The company operates out of a single

facility in Florence, Alabama, with over 130,000 sq. ft. of manufacturing capacity for pre-engineered metal buildings. The company’s products are used in commercial, post-frame/agricultural and other industrial applications. Its customer base consists primarily of contractors.

Union is a manufacturer of metal roofing systems, roofing components, and pre-engineered metal buildings. Its products are used in residential, post frame/agricultural and commercial applications and are sold through lumber retailers, home centers, wholesalers, contractors and directly to consumers. Union is based in Fayetteville, North Carolina, with 17 additional manufacturing and distribution facilities located throughout the Southeast, Mid-Atlantic, and Midwest U.S.

Union President and Chief Executive Officer Keith Medick noted, “The addition of Oakland Metal Buildings significantly increases our manufacturing capacity for metal buildings and allows us to continue growing that business while also giving us a location in the Alabama market from which to sell Union’s metal roofing products.”

■ AZEK BUILDING PRODUCTS PARTNERS WITH SNAVELY FOREST PRODUCTS

AZEK Building Products, a manufacturer of premium outdoor building materials, has announced a new partnership with Snavely Forest Products. The wholesale distributor of building products plans to offer the full lines of TimberTech and AZEK Exteriors products in key locations throughout Colorado and Wyoming.

The TimberTech and AZEK Exteriors portfolio of products provides customers with a range of high performance, low maintenance alternatives to wood. The products are made from a majority of recycled polymer to create an eco-friendly product.

AZEK Building Products manufactures all products in the United States.

Snavely Forest Products partners with both domestic and international manufacturers. Together, they are set to partner at distribution centers across Colorado and Wyoming with potential to expand to other locations in the future. **RB**

LEVI'S
BUILDING COMPONENTS

High Quality Products For A High Quality Job

Call To Find A Supplier Near You
877-897-7020
levisbuildingcomponents.com

Circle Reader Service #392

supplier news

BY RURAL BUILDER STAFF

FASCO REBRANDED AS BECK AMERICA

BECK has changed. From the first collated staple, to the invention of SCRAIL, the nail and screw combination fastener, or LIGNOLOC, the first collated nail made of wood – the company from Austria now has a new umbrella brand and brand design.

“Our business has undergone a significant transformation in the past few years. Against the backdrop of digitization and the dynamics of continuously changing markets and customer expectations, we recognized that our company needed to modernize its brand strategy in order to remain up to date,” announced Christian Beck, General Manager and CEO of BECK, at the launch of the new corporate brand identity on September 16.

The umbrella brand name is changed from BECK Fastener Group to BECK.

As part of the new brand identity, BECK also decided to streamline the brand architecture. They reduced the number of brands and established a consistent brand family with a clear new brand structure (as seen in the graphic). In this context, FASCO America was renamed BECK America. BECK America



Christian Beck, General Manager and CEO of BECK.

now clearly appears as a BECK company that not only sells FASCO tools but also the whole BECK product brand range.

Through an exhaustive 20-month effort the new BECK brand was born. During this process, the company was encouraged to represent its competencies clearly, to simplify communication and to improve the customer experience.

“The main idea behind all these steps: to pull all of our strengths and to appeal to the customer by simplifying the way we approach the market,” Beck said. “We’re proud of the work that we do here at BECK and we are looking forward to further strengthening and expanding the cooperation with our business partners through our brand.”

The transition will take place gradually over a period of one year as the migration rolls out in a step-by-step migration process.

BECK is a family company founded in 1904. For more than 110 years, BECK has been one of the world’s leading manufacturers of innovative fastening solutions. BECK is now a globally active, family-owned company with sites in Austria, Germany, Italy, Poland, and the USA.

rebranding.beck-fastening.com

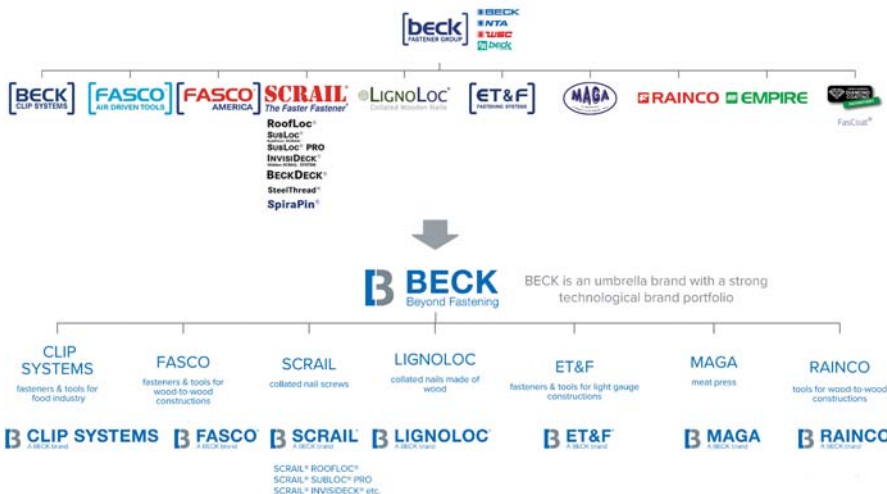

PLYCO NAMES GRANTIZ AS NATIONAL SALES & MARKETING DIRECTOR



Tom Grantiz, National Sales & Marketing Director of Plyco

Plyco Corporation has named Tom Grantiz as its new national sales and marketing director. Since 1989, Grantiz has worked in various positions with Dominion Building Products, EXPI-Door and most recently, as general manager for Diamond Door Products at the Elkhart, Indiana, manufacturing facility.

MAKITA HONORED FOR BATTERY RECYCLING PROGRAM

Makita U.S.A., Inc. has been recognized for outstanding battery recycling efforts with the Call2Recycle 2018 Leader in Sustainability Award. Call2Recycle is the country’s first and largest consumer battery recycling program.

Makita’s engagement contributed to the diversion of 7.2 million pounds of batteries from U.S. landfills through the Call2Recycle program in 2018.

Makita was one of the first power tool manufacturers to join Call2Recycle in the mid-1990’s and has worked with Call2Recycle to develop new ways to collect, package, and ship used batteries at the end of their life cycle to recycling centers. Each Makita lithium-ion battery carries the Call2Recycle Battery Seal, which includes a toll-free phone number to locate a battery collection site.

For more information, visit www.call2recycle.org.

calendar

BY RURAL BUILDER STAFF

November

6-8, Design-Build Conference & Expo, Las Vegas.
www.designbuildexpo.com

December

5-6, Metal Roofing From A (Aluminum) To Z (zinc) Course, University of Wisconsin-Madison; <https://epd.wisc.edu/course/metal-roofing-systems>

12-13, 1st Annual Construction Rollforming Show, Duke Energy Center, Cincinnati, Ohio. Sponsored by *Rollforming Magazine*. For exhibitor information contact Gary Reichert, 715.252.6360; gary@shieldwallmedia.com

2020

January

13-15, Metal Construction

Association (MCA) Winter Meeting 2020. Indian Wells, California; www.metalconstruction.org

21-23, International Builders' Show (IBS) 2020. Las Vegas.
www.buildersshow.com

22-23 Northwestern Building Products Expo — North. St. Cloud, Minnesota. www.nlassn.org

February

1-5, ASHRAE Winter Conference 2020, Orlando, Florida.
www.ashrae.com

4-6, International Roofing Expo (IRE) 2020. Dallas, Texas;
www.theroofingexpo.com

10-13, American Architectural Manufacturers Association (AAMA) Annual Conference 2020. Fort Lauderdale, Florida. www.aamanet.org



Join over 14,000 roofing professionals for the industry's largest event — the International Roofing Expo. At the IRE you will make connections with both residential and commercial contractors, remodelers, distributors, estimators, specifiers, architects, engineers, builders, and manufacturers.

Explore thousands of products from over 500 brands, select from over 40 educational sessions, participate in the 11th annual Community Service Day, take part in NRCA events, attend networking receptions and more. Join us in Dallas, Texas, February 4-6!

new products

BY RURAL BUILDER STAFF

LACROSSE ALPHA RANGE

Nothing is worse than cold, wet feet when you are trying to get work done! The LaCrosse Alpha Range has quickly become a go-to work boot for getting the job done. The range is growing with a new model that incorporates a composite safety toe, metatarsal guard, puncture resistance and electrical hazard protection. This boot is designed for any job site or task in the worst wet and muck, protecting your feet and keeping you dry. These boots are great for 60 degrees to -20 degrees F.

The boots feature:

Hand-laid premium ZXT rubber over a 5mm neoprene core for durable, flexible, waterproof comfort; Active Fit with adjustable gusset for easy on/off and a secure, comfortable fit on foot; textured finger grips and angled top band make it easy to grab hold and pull on; and moisture wicking and quick drying polyester jersey liner

Non-metallic safety toe, metatarsal guard, and puncture resistant midsole. MSRP: \$160.

www.lacrossefootwear.com

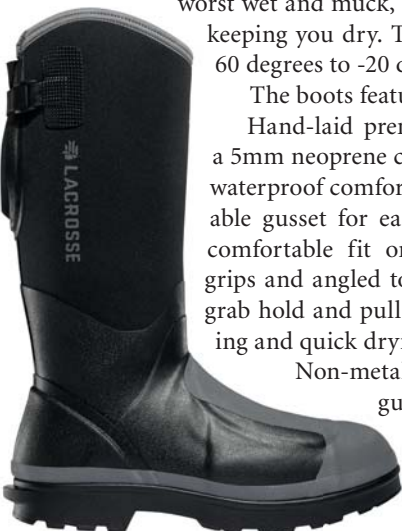

7-INCH GUTTER GUARD

Leaf Solution has added 7-inch Xtreme Gutter Guards to their product mix of 5-inch and 6-inch guards for residential or commercial installation.

Xtreme features .42 stainless-steel mesh to block all debris from leaves to pine needles, from oak tassels to shingle grit to pollen, yet allows water to flow freely into the gutter. A durable substrate backing reinforces the mesh, horizontally and vertically, from stretching or sagging and simplifies installation.

Components are assembled with a patented hemming process that prevents separation. Engineered to outperform and outlast comparable gutter guards, Leaf Solution Xtreme has a 20-year transferable warranty and is made in the United States. Available for fascia or under-shingle mount, in mill silver or black. leafsolutionusa.com





Mark Battersby has more than 35 years experience in small business issues, tax and financial matters. Contact him at 610-789-2480 or MCBatt12@Earthlink.net.

Getting A Head Start On Tax Savings

GOOD TAX PLANNING IS BASED ON A RURAL BUILDINGS BUSINESS'S CURRENT VERSUS POTENTIAL FUTURE EARNINGS OR PROFITS.

For those builders and contractors whose taxable earnings will potentially be lower next year, end of the year tax planning is very simple: Defer any income possible, pushing it onto next year's lower tax bill.

In addition to deferring income until next year when the tax bill, if not the tax rates, may be lower, it might be more valuable to accelerate deductions into the computation of the current tax year's tax bill. However, while many approaches either don't work or only result in a deferral of taxes, tax bills can be reduced using timing, making a few key moves, and by spending money on specific things. Consider, as one example, pre-paying some deductible expenses.

Those in need of extra business deductions before the end of the year can prepay some expenses, such as business insurance, rent on shops and equipment and lease payments on business vehicles. The general rule is that expenses for a future year cannot be prepaid and deducted from the current year's tax bill.

An expense paid in advance can only be deducted in the year to which it applies. Fortunately, there is an exception, the so-called "12-month" rule, that allows the building business to deduct prepaid future expenses in the current year if the expense is for a right or benefit that extends no longer than 12 months or until the end of the tax year after the tax year in which the payment is made.

The 12-month rule can apply to business insurance premiums, licenses, rents and leases as well as to payments for terminating business contracts. It may not, however, be used for payments for interest, loans and other financial interests or purchases of furniture, fixtures, equipment, or other long-term capital assets.

Bottom-line, whether prepaying expenses makes sense depends on the expected tax bill for this year compared to future years, as well as future changes predicted for our tax laws that might raise the building operation's taxes. If income is expected to go up substantially next year, not prepaying expenses, but instead maximizing deductions next year, might be the best option.

The 2017 Tax Cuts and Jobs Act (TCJA), along with other legislation increased the write-offs for certain types of business equipment. The accelerated depreciation deductions apply to the cost of business equipment purchased during the year but go much further. Consider:

BONUS DEPRECIATION

The TCA created a tax deduction for the entire cost of new purchases with 100 percent bonus depreciation. With bonus depreciation, the cost of computers, equipment, vehicles, and furniture acquired in the 2019 tax year can be written-off.

SECTION 179 EXPENSING

There is also the increased Section 179, first-year expensing write-off that has been doubled from \$500,000 to \$1,000,000. Section 179 property now also includes fire protection, alarm systems, and security systems.

ENERGY EFFICIENT PROPERTY

Every business can get a tax credit, a direct reduction of the tax bill rather than a deduction from the amount that tax bill is based on, for investing in specific energy-saving improvements and projects. These investments must be in "investment credit property" that can be depreciated or amortized. The amount of the tax credit is: 30 percent for solar, fuel cells, small wind turbines, etc., and 10 percent for geothermal, microturbines, and combined heat and power.

REPAIRS

In 2013 the IRS issued regulations that kicked in during the 2016 tax year and impacting every building business with fixed assets. Today, the so-called "de minimis" safe harbor deduction for materials and supplies has been increased from \$500 to \$2,500, at least for those businesses without an applicable financial statement. It is not too late to update the building operation's policy for differentiating repairs from capital expenditures to comply with the updated regulation.

VEHICLE EXPENSES

What percentage of a vehicle used in or by the building business is attributable to business usage?

Tax

bills can be reduced using timing, making a few key moves and by spending money on specific things.



Whatever the percentage, that amount may qualify as an auto expense. The IRS allows two ways to calculate the deduction. First, there is the actual expense to which the percentage is applied to create the business auto expense deduction. Or, tracking the actual mileage for business purposes and using the 54.5 cents per mile standard write-off. But, don't forget the write-off ceiling on the vehicle's cost.

With income, the general rule for cash-basis building operations and businesses is it doesn't have to report income until the year cash is received or a check is in hand. Most small businesses are allowed to use the cash-method of accounting for tax purposes.

A business operating on a cash basis for tax purposes, anticipating higher profits in 2020 than in previous years, may want to defer revenue as a way of reducing taxable income for 2019. Consider billing late in December or delaying the delivery of certain products or services until January.

Alternatively, if the building business is expected to be more profitable next year, accelerating cash collection before December 31 would allow those amounts to be taxed at a lower rate.

The purpose of records is two-fold. First, they provide a reminder of income and expenditures, plus they serve as proof should it be demanded by the vigilant IRS. Yes, good records will help monitor the progress of the building business, prepare its financial statements, identify sources of income, keep track of deductible expenses and aid in preparation of the annual tax returns.

Expense records are important for deductions and lowering taxable income. Here, cancelled checks may not always do

the trick as IRS auditors want invoices, bills, and contracts explaining those cancelled checks. And, the time to assemble those records is now, *before* the end of the tax year.

As the end of the building operation's tax year approaches, several general rules might help guide it to real tax savings — savings that will be consistent, year-after-year:

- **Don't spend money simply to reduce that tax bill.** After all, \$1 spent does not equal \$1 worth of tax saved or create a \$1 deduction. Also, keep in mind that if those accelerated deductions result in a net operating loss (NOL), as mentioned, it can now only be used to offset tax bills down the road — there is no longer a NOL carryback.

- **Know thy accounting method.** Most year-end tax strategies work best for cash-basis taxpayers. Accrual-basis building businesses report all income in the year it is earned and all expenses in the year they are incurred. So, just because the building business is paying for a 2020 expense in 2019 doesn't always result in an immediate deduction on the 2019 tax return.

- **Worker classification matters.** Every building business owner must correctly determine whether workers are employees or independent contractors. Independent contractors are not, of course, subject to withholding, making them responsible for paying their own income taxes plus Social Security and Medicare taxes.

Once the work is done and the alternatives tested, do you opt for a series of aggressive year-end tax strategies? While it is almost always recommended, few builders, contractors, or business owners seem to get their tax professionals involved well before the end of the tax year. **RB**

1ST ANNUAL

Construction Rollforming Show 2019

DECEMBER 12-13

Duke Energy Convention Center

CONMAT

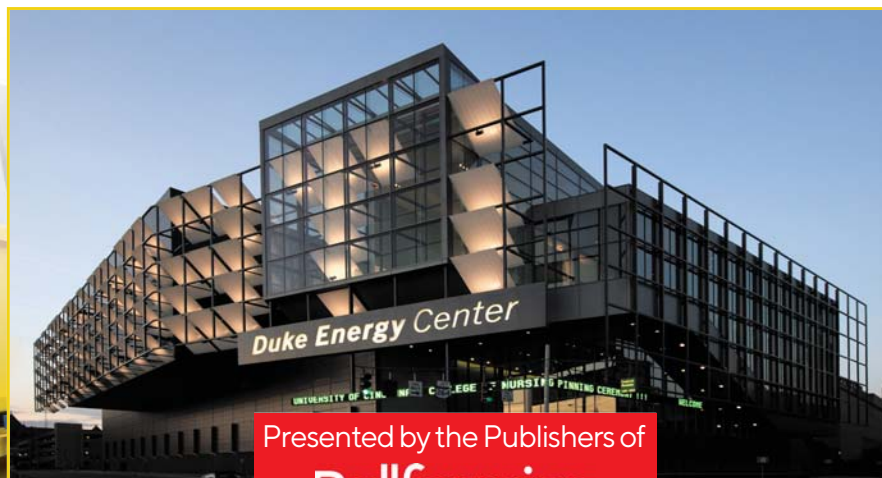

Presented by the Publishers of

Rollforming
Magazine

**ONLINE
REGISTRATION
NOW OPEN!**

[constructionmagnet.com/
construction-rollforming
-registration](http://constructionmagnet.com/construction-rollforming-registration)

ONLINE REGISTRATION
CLOSES NOVEMBER 22nd

SHOW DETAILS

EXHIBITORS:

- 15,000 + square feet of roll forming exhibitors
- Roll formers
- Coil suppliers
- Paint and coating manufacturers
- Clips, clamps and components
- Design software
- Efficiency and automation software
- Snow retention, ventilation and moisture control

EDUCATION:

- Inventory control and management
- Improving quality and productivity
- Coil and steel metallurgy and properties
- Paint and coating technology
- Business best practices and development

SPECIAL PRESENTATION: Friday, December 13

- Industry metrics on roll forming in the construction industry
- Market size, trends and direction
- Growth potential



We are still looking for presenters and additional suggestions for the educational programming. If you would like to be considered as a possible presenter, or have a suggestion for a topic, please contact Gary Reichert. We value your input and suggestions.

EXHIBITORS

COMPANY	BOOTH #	COMPANY	BOOTH #	COMPANY	BOOTH #
3GM/Mac Metal	416	Drexel Metals	110	Northstar Metal Manufacturing	122
AB Martin Roofing Supply	623	Dynamic Fastener	327	Onduline North America	102
Ace Clamp	709	Fasteners Direct	708	Paint Valley Parts/Acu-Form	715
Akzo Nobel	523	Flack Global Metals	222	Palram Americas	202
Albatross LLC	628	Graber Post Buildings	428	Paragon	224
American Producers Supply	101	Hershey's Metal Meister	501	Plyco Corporation	227
Ameripak	616	Hixwood Metals	221	SAMCO Machinery	216
AMS Controls	216	Johnson Rollforming	117	Sheffield Metals	606
ASC Machine Tool	610	Keymark	515	Sherwin-Williams Coil Coatings	418
Atlas Bolt & Screw	215	Kloeckner Metal	618	Snap-Z	113
Beck Automation	422	Levi's Building Components	204	Star 1 Products LLC	710
Bradbury Group	316	Liberty Steel	524	ST Fastening Systems	528
Cannonball	522	Marco Industries	624	Stoll Metal Works	702
Capital Forest Products	621	Metal Rollforming Systems	201	Swenson Shear	701
County Line Concepts	521	Mill Steel	711	SWI Machinery	302
Crossridge Marketing	109	MWI Components	309	United Steel Supply	301
Direct Metals	112	NC Automation	228	Ventco	321
Drlpstop	209	New Tech Machinery	602	Zimmerman Metals	210

Thank you to our **PREMIER Sponsors** for promoting the **2019 CONSTRUCTION ROLLFORMING SHOW!**



For more information, contact: Gary Reichert
gary@shieldwallmedia.com • 715-252-6360

DYNA-GUARD®



IT IS TIME FOR A
**CHANGING OF THE
GUARD**

DYNA-GUARD® is a snow retention system designed to be installed on metal roofs. We are discontinuing the line of **S-5!** and related products. Please call for our close-out prices on S-5!®



DYNA-GUARD® Snow Retention System installed on a metal roof.

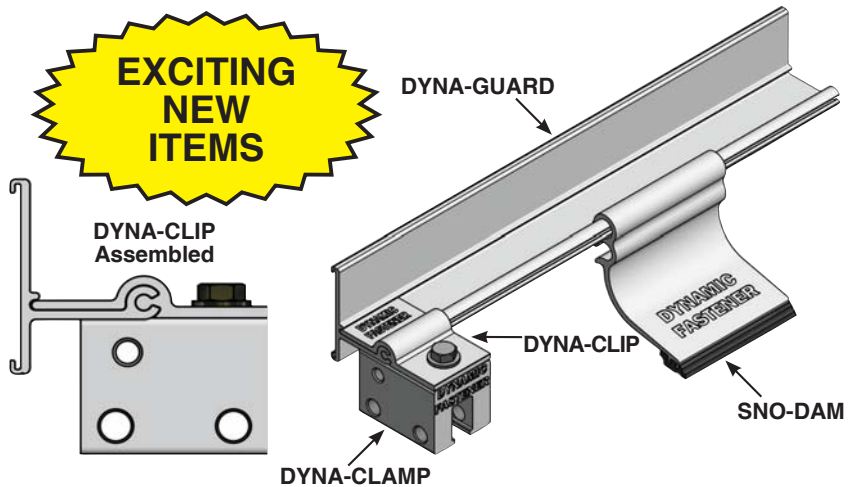
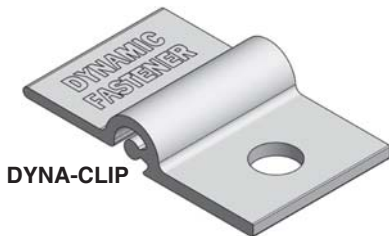

DYNA-CLIPS™

Clips for connecting

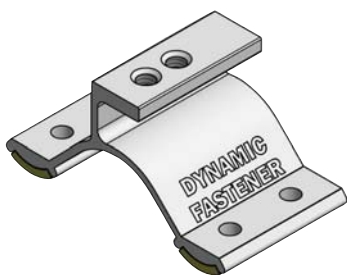

DYNA-CORR™
Attach almost anything
to a corrugated roof

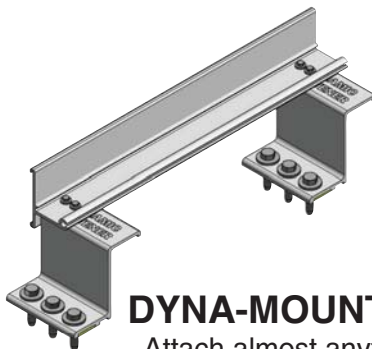

DYNA-MOUNTS™
Attach almost anything
to an exposed fastener
trapezoidal roof



Retro SNO-DAMS®
Retro-fit existing
DYNA-GUARD by
pressing these onto an
installed system



DYNAMIC FASTENER • 800-821-5448

S-5! is a registered trademark of Metal Roof Innovations Ltd. DYNA-GUARD, DYNA-CLAMP and SNO-DAM are registered trademarks of Dynamic Fastener Service Inc. DYNA-CLIP, DYNA-CORR & DYNA-MOUNTS are trademarks of Dynamic Fastener Service Inc.

Circle Reader Service #316